

Optimal sizing of a stand-alone photovoltaic system with energy management in isolated areas

Smail Semaoui^{a*}, Amar Hadj Arab^a, Seddik Bacha^b, Boubekeur Azoui^c

^a Centre de Développement des Energies Renouvelables, BP 62 Route de l'Observatoire Bouzaréah, 16340 Algiers, Algeria

^b Grenoble Electrical Engineering Laboratory (G2ELAB), 38402 St Martin d'Hères - France

^c Faculty of Technology, Hadj Lakhdar University, 05000 Batna - Algeria

Abstract

In this paper, a model of optimal sizing was recommended, to optimize the sizes of batteries capacity and photovoltaic (PV) generator for a standalone PV system without extra and with energy management of load. The recommended model was implemented in Matlab-Simulink, takes into account the sub-models of the standalone PV system and the strategy of load management. This model uses two optimization criteria, the loss of power supply probability concept for the reliability and the energetic cost for the economic evaluation. The former is achieved by reducing the loss power supply probability and by reducing the shadings of load. The last is attained by lowering the batteries replacement during the operating years of the PV system, through the improvement of the battery life cycle. The adopted methodology is based on the real consumption profiles, real weather conditions, energy storage capacity and PV array peak power. A case study was conducted to an electrification project with the autonomous photovoltaic systems, which is intended to remote and scattered housings in Ghardaia site, Algeria.

© 2013 The Authors. Published by Elsevier Ltd. Open access under [CC BY-NC-ND license](https://creativecommons.org/licenses/by-nc-nd/4.0/).
Selection and/or peer-review under responsibility of the TerraGreen Academy

Keywords: Stand alone photovoltaic system; load profile; energy management; storage; modeling; simulation; climate.

1. Introduction

Crude oil, coal and gas are currently the main resources for the energetic world supply. The size of the reserves of these fossil resources is in rapidly decreases. This topic is fundamental and doubtful, giving a reflection for the future. World reserves of coal, oil and gas proved in December 2011 (ratio Reserve/Production) are respectively about 112, 63.6 and 54.2 years [1]. The depletion of fossil fuels, the pollution and the climatic change impose the need of the energetic diversification by the rapid integration of renewable energies. The world has a considerable solar energy potential. However, its use requires

* Corresponding author. Tel.: +21321901503; fax: +21321901560.
E-mail address: smsemaoui@yahoo.fr.

improving the efficiency of exploitation devices, such as photovoltaic systems, to ease access at public for using these means. Photovoltaic systems may, in general, be operated as a hybrid, grid connected, or stand-alone systems. Stand-alone PV systems have a wide application in remote isolated regions to meet at need in electric energy. A proper match between the size of stand-alone PV system and the consumption in isolated site is essential to ensure the energetic supply. The selection of optimal sizes for various components, such as the PV array and the storage capacity, is relating to the uncertainty associated with the available solar radiation and the load behavior. In the literature, most methods and techniques of sizing optimization are used for PV systems without load management. [2,3] are developed an optimization method applicable to stand-alone photovoltaic systems and photovoltaic water pumping systems for various areas all over Algeria. [4] are proposed a methodology for the optimum sizing of photovoltaic-battery system for remote electrification incorporating the uncertainty associated with solar irradiation. A methodology are developed by [5], this methodology is able to define the dimensions of an autonomous electricity generation system based on the maximum available solar potential exploitation at minimum electricity generation cost. For studying the impact of load profiles on gross energy requirement, a methodology is proposed by [6].

The main objective of the present work is to include the developed load management in the technico-economic optimization on the life cycle (estimated at 25 years) of a SAPS. In this study, two criterion for optimizing the SAPS was used. The former is the loss power supply probability (LPSP) for reliability. The last is the energetic cost of the PV system for economic criterion.

2. PV system Description

2.1. Application site

The study focuses on a housing located in Ghardaia region (Southern Algeria, 32°29'N, 3°40'E, 450m). This region is located in the heart of Algeria, with famous architectural and social specificities. Ghardaia is ranked by the UNESCO among the world patrimony [7]. During centuries, Ghardaia conserved practically the same housing mode and the same building techniques, controlled by original culture; this is to cope with the hostile environment.

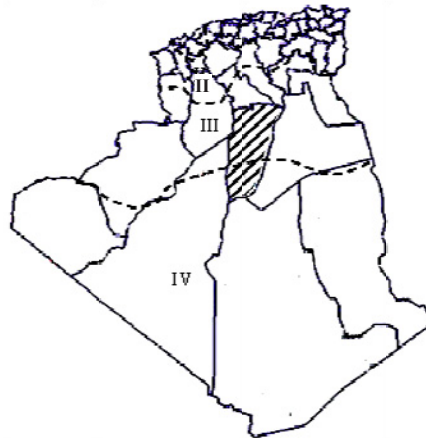

Fig. 1. Algerian climatic zone repartition

The weather conditions mean that Ghardaia benefits from dry and arid climate. Indeed, it is ranked in the third climatic zone (See Fig 1.) [2]. This region is characterized by exceptional sunlight. The annual amount of energy measured on a slope plane at 32° is 2364 kWh/m², with a summer average of 7.4115

kWh/m²/day and an average of 4.956 kWh/m²/day was measured as the most unfavorable month (December). The slope of 32° was chosen according to the optimization done for different fixed slopes, each one during a whole year [8].

2.2. Stand alone PV system

The study of the PV system’s behavior required the input of three major parameters, solar irradiance (G_a), ambient temperature (T_a) and the power load (P_{load}). Fig. 2 shows the study SAPS with load management device (LMD).

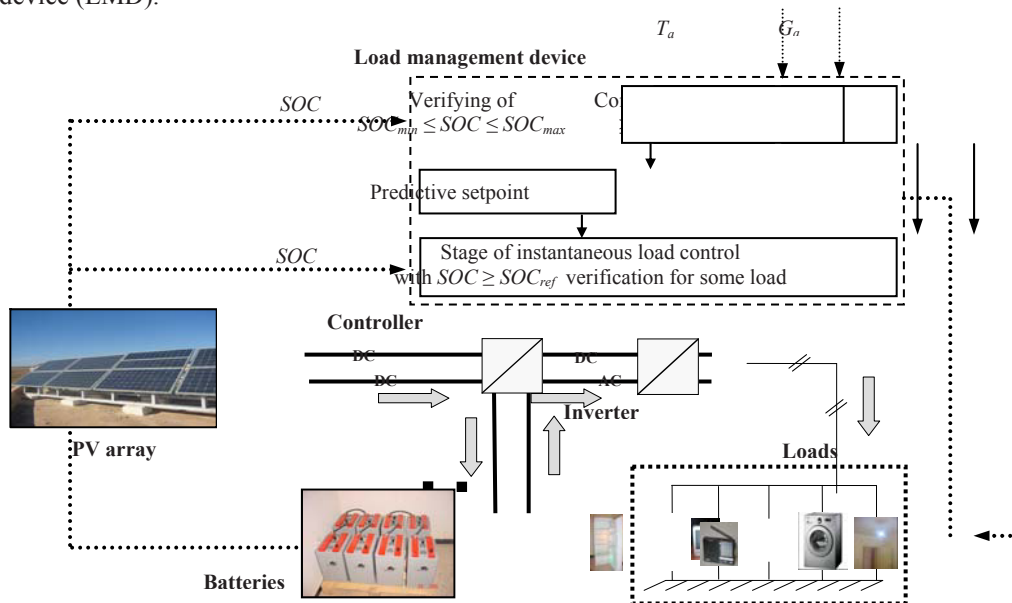

Fig. 2. Stand alone PV system with load management device

The SAPS includes the PV array consists of polycrystalline modules (TE500), the storage batteries of the lead acid technology and the power conditioning device. The PV module characteristics at STC (1000 W/m², 25°C) is given by Table 1.

Table 1. The manufacturer characteristics of PV module

TE500 module	P_p	I_{SC0}	V_{OC0}	I_{max0}	V_{max0}	N_s
Values	55	3,5	21,7	3,142	17,5	36
Units	W	A	V	A	V	-

The nominal voltage of the battery element used was 2V. The power conditioning device is a set of controller and inverter.

2.3. Weather data collection

A data acquisition system was installed in order to ensure the data collection of the various climatic parameters. For irradiation measurement, a CM11 Pyranometer type with a sensitivity equal to $4.57 \cdot 10^{-6}$

V/Wm^{-2} was used. The solar irradiation and the ambient temperature profiles measured are shown respectively by Fig. 3(a) and Fig. 3(b). The disparity of the temperature was noticed between the winter solstice and the summer solstice. This phenomenon really influenced the proper functioning of the PV array (Yielded reduction at high temperatures).

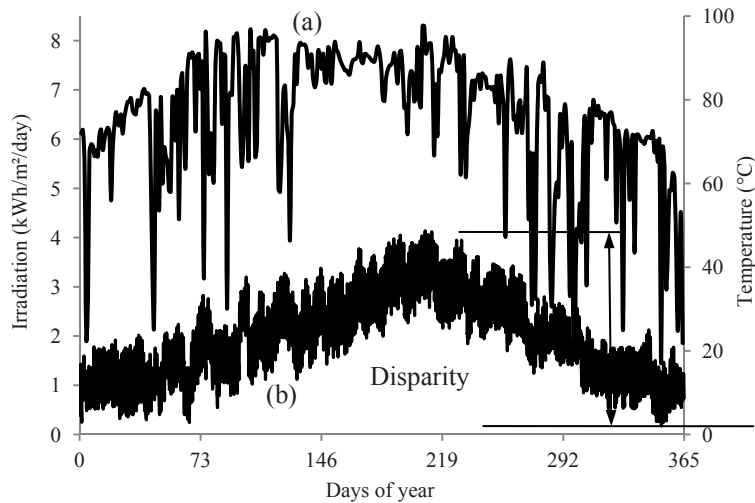

Fig. 3. (a) Solar irradiation on slope plane; (b) Ambient temperature

2.4. Load Profile

A real investigation was done on daily electricity consumption in the city of Tafilalt (Ghardaia) on a set of houses.

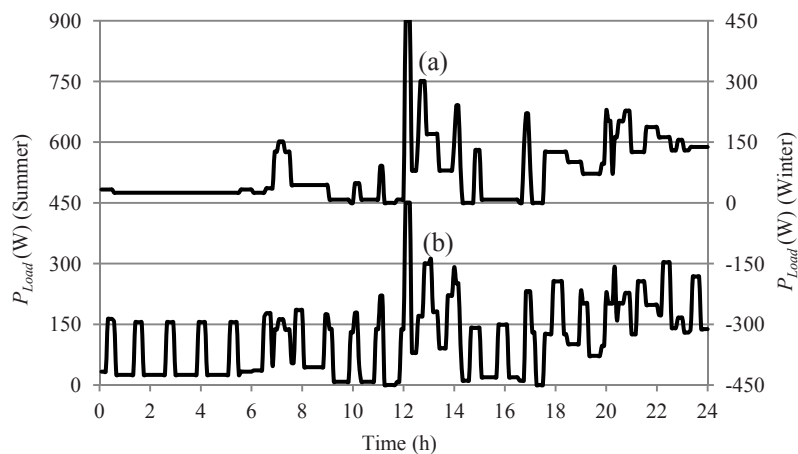

Fig. 4. Daily load profile developed. For example, (a) Winter; (b) Summer

After data treatment, the load profiles illustrated in Fig. 4(a) for winter season and Fig. 4(b) for summer season were defined. The used charges to obtain this profile are: Television (TV), radio, washing machine, refrigerator, fan and low consumption bulbs.

2.5. Principle of developed Load management

In This study, the load profile presented in Fig. 4 was used. According to the managerial strategy, the loads used in the habitat were divided into two types, as follows:

- Non-controlled loads such as the refrigerator and lamps of rooms and toilets.
- Controlled loads were washing machines, radios, lamps in kitchens and lounges, TV and fans.

The main objective was to improve the efficiency of the SAPS and minimize the batteries replacement; of course, with the respect of house comfort. To achieve this aim, the management device used in the study is screened in Fig. 2. As the figure shows, the LMD is composed of three parts which correspond to three inputs which are: SOC , T_a and G_a . Each part was intended to control different types of loads such as of the washing machines, the fans and the light ...etc.

From these three inputs, a load management plan was calculated to moderate the storage use. Consequently, the batteries charge during the sunshine period was favored; the strong current request was reduced from the storage. The means of improvements applied are presented below:

The starting time of the washing machine in the day is decided at midnight of previous day, according to the $SOC(t)$ measured at time of the deciding, which give an idea about the energy amount produced during the same day. The lamp functioning time was controlled without affecting visual comfort, according to the outside light which was compared to a reference of irradiance $G_{a,ref}$. Because these traditional habitats are usually illuminated by a large square opening towards the sky, which also permits aeration [7]. Likewise, the functioning time of the fan was controlled according to the ambient temperature which was compared to a reference temperature T_{a_ref} .

3. System modeling

3.1. PV module model

The model of PV module described by the Eq. (1) is implicit [9,10]. This is the same electric equivalent model at one diode for a cell. The advantage of this model is that it can be established by the application of standard data given by the manufacturer [10]. Therefore, module current I relation with the tension V can be described in arbitrary functioning conditions as follows.

$$I = I_{SC} \left[1 - \exp \left(\frac{V - V_{OC} + R_s \cdot I}{N_s \cdot m \cdot k \cdot T^c / e} \right) \right] \quad (1)$$

Where, N_s is the cell number in series and m is the ideality factor equal to 1,2 for the mono-crystalline and 1,3 for polycrystalline silicon [11]. The cell series resistance R_s , the short-circuit current I_{SC} , the open circuit voltage V_{OC} and the cell temperature T^c are calculated with the real weather data, such as the solar irradiance G_a and the ambient temperature T_a . As well as, the parameters given by the manufacturer [10].

3.2. Battery model

At present, the widespread SAPS storage technology is the Lead acid technology. This latter is treated on different literature [12,13,14], due to the compromise of its advantages: availability, cost and reliability. For the considered system simulation, the CIEMAT battery model was used, as it is described in several articles [15,16]. The battery modeling is necessary, particularly to establish instantaneous state of charge $SOC(t)$ (Eq. (2)) in the optic to manage the energy within the system.

$$SOC(t) = \frac{C_{Sto}(t)}{C_{nom}(t)} \quad (2)$$

Where, $C_{Sto}(t)$ is the battery instantaneous capacity and $C_{nom}(t)$ is the battery nominal capacity at time t which is varying by the ageing effect against the referential nominal capacity C_{nom0} [17].

3.2.1. Battery Charging

In charge mode, the instantaneous state of charge $SOC(t)$ is described by Eq. (3). Where, η_{Coul} is the instantaneous charge efficiency and $I_{bat}(t)$ is the instantaneous charge current of the battery [16].

$$SOC(t+1) = SOC(t) + \frac{\eta_{Coul}(t) \cdot I_{bat}(t) \cdot \Delta t}{C_{Sto}(t)} \quad (3)$$

$$\Delta t = 300 \text{ s}$$

3.2.2. Battery discharge

In discharge process, the efficiency was considered unitary [16]. The Eq. (4) show the state of charge of battery.

$$SOC(t+1) = SOC(t) - \frac{I_{bat}(t) \cdot \Delta t}{C_{Sto}(t)} \quad (4)$$

These equations described above are experimentally validated by [16].

3.2.3. Ageing model

The models of assessing the health status of the batteries are illustrated by several authors [13,17]. The instantaneous state of health $SOH(t)$ of battery is described by Eq. (5). The main objective for this work is to minimize the storage use or to extend the battery's life cycle.

$$SOH(t) = \frac{C_{nom}(t)}{C_{nom0}} \quad (5)$$

The method used in this study is dictated by [17]. This involves taking into account the instantaneous value of the battery nominal capacity, which degrades at each discharge. This phenomenon can monitor the health status of the battery in a precise manner. The nominal capacity degradation model $C_{nom}(t)$ is presented in the Eq. (6) below :

$$C_{nom}(t) = C_{nom}(t-1) - C_{nom0} \cdot \delta_x \cdot (SOC(t-1) - SOC(t)) \quad (6)$$

Where δ_x is the capacity loss coefficient, and for acid lead batteries $\delta_x = 0.3\%$ [17].

3.3. Inverter model

Usually in the world, the loads at alternative current are used for homes; this requires the use of a DC/AC inverter. The inverter energetic performance is not constant. Efficiency of inverters depends on their output powers. In this case, the polynomial performance model was used; it is illustrated down by Eq. (7) [17]. This model is experimentally validated by [18].

$$\eta_{inv}(t) = \frac{I}{I + \frac{\alpha_{inv}}{P_{Load}(t) \cdot \varphi_{sinv}} + \beta_{inv} + \gamma_{inv} \cdot P_{Load}(t) \cdot \varphi_{sinv}} \quad (7)$$

Where, $P_{Load}(t)$ is the instantaneous load power and φ_{sinv} is described by Eq. (8), which is the ratio between the inverter reference power ($S_{inv,ref} = 4,5 \text{ kVA}$) and the inverter nominal power (S_{inv}). The given

values for parameters α_{inv} , β_{inv} and γ_{inv} are respectively, 43.09 [SI], 4.6×10^{-3} [SI] and 3.34×10^{-5} [SI]. According to [17], these parameters allow modeling inverters of different sizes.

$$\varphi_{inv} = S_{inv,ref} / S_{inv} \tag{8}$$

3.4. Optimal sizing criteria for SAPS

3.4.1. Reliability criterion

In this study, the reliability is expressed in terms of *LPSP*. The loss of power supply probability for a considered period is expressed by Eq. (9) [19]; it is defined as the ratio of the sum of demanded energies but not consumed (*LPS(t)*) on the sum of energy demand during the year ($E_{Ld}(t)$).

$$LPSP = \sum_{t=1}^{t_{sim}} LPS(t) / \sum_{t=1}^{t_{sim}} E_{Ld}(t) \tag{9}$$

The deficit called loss power supply at time *t* (*LPS(t)*) is expressed below (Eq. (10)):

$$LPS(t) = E_{Ld}(t) - E_{Lc}(t) \tag{10}$$

Where, $E_{Lc}(t)$ is The consumed energy by the load at the time *t*.

3.4.2. Economic criterion

For an SAPS, the energetic cost (*EC*) expressed by Eq. (11) is mainly linked to three sizes, which are the peak power of the PV array (P_{pv}), the nominal capacity of storage (C_{nom}) and the apparent power of the inverter (S_{inv}) [6].

$$EC = EC_{pv} \cdot P_{pv} + n_{sto} \cdot EC_{sto} \cdot C_{nom} + n_{inv} \cdot EC_{inv} \cdot S_{inv} \tag{11}$$

Where, n_{sto} and n_{inv} are respectively the number of lead-acid battery replacements and inverter over the SAPS life cycle. In this paper, a period of 25 years (the estimated PV module lifetime) was chosen. The life cycle of inverter is estimated at 10 years. The energetic cost parameters EC_{pv} , EC_{sto} and EC_{inv} are given respectively $8,9 \text{ kWh}/W_C$, $359 \text{ kWh}/kWh$ and $0,3 \text{ kWh}/VA$ [20,21].

3.5. System Programming in Matlab-Simulink

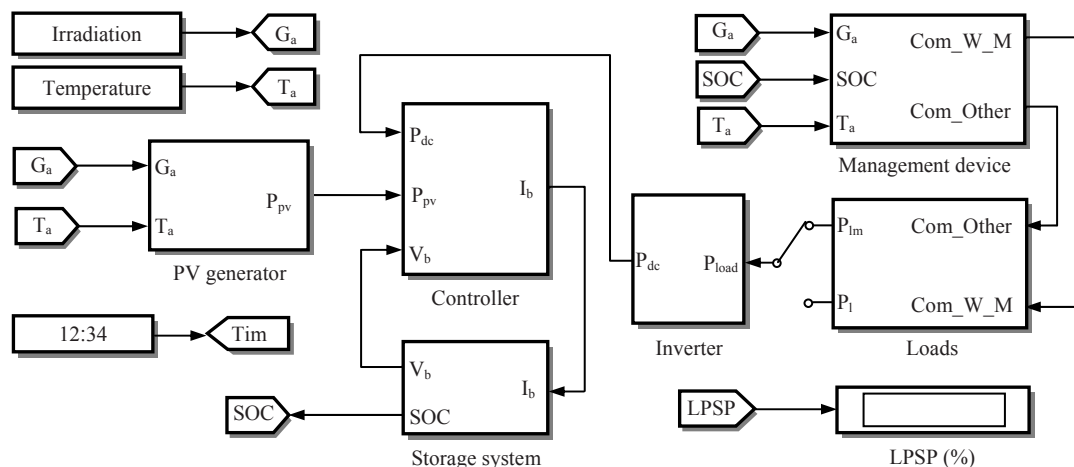

Fig. 5. Matlab-Simulink program of SAPS

The elaborated Matlab-Simulink program is shown in Fig. 5. This program contains the models of the PV sub-systems with the device of load management. The simulation was performed with a real yearly profile of data from Ghardaia site. The step time (Δt) of this simulation was 5 minutes depending on data acquisition process; the simulation time (t_{sim}) was added up from 1 to 25 years.

4. Simulation results and discussion

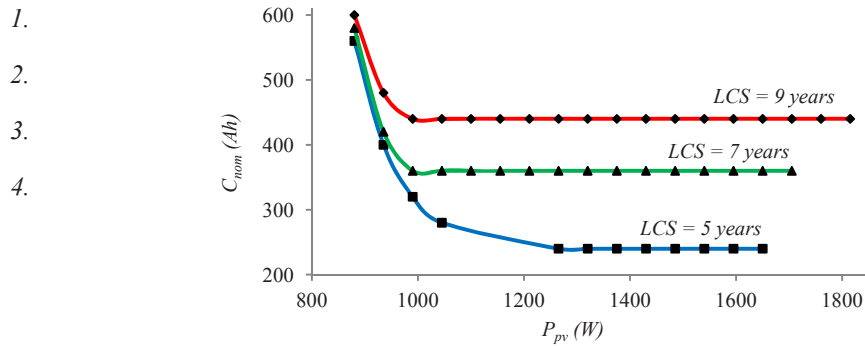

Fig. 6. System configurations with load management for different life cycle of storage (LCS)

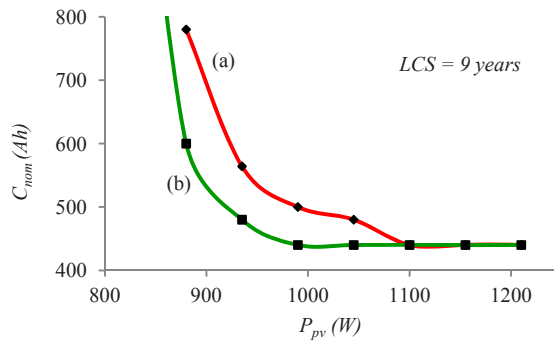

Fig. 7. System configurations, (a) Without load management; (b) With load management

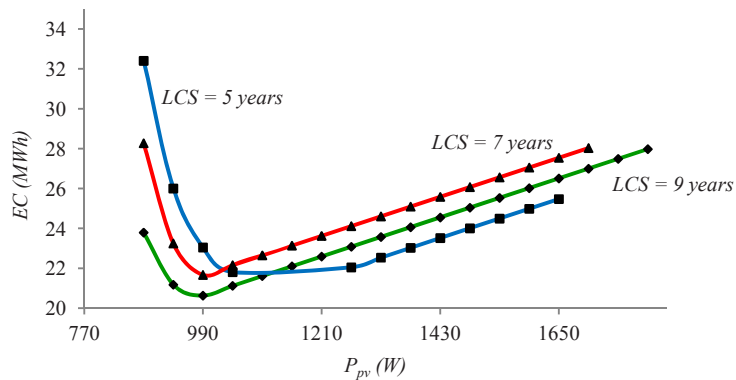

Fig. 8. Energetic cost of system configurations with load management

Considering the main constraints $LPSP \leq 1\%$ and $SOH(t) \geq 80\%$, The simulation results are presented by the hereinafter figures. Fig. 6 shows the system configurations with load management for different LCS . The Fig. 7 shows that the load management minimizes the nominal capacity of storage at powers of P_{pv} less than 1100 W. Consequently, the relative cost to the storage is minimized. The energetic costs of the system configurations presented in Fig. 8 was calculated for 25 years of PV system life cycle. The optimal size (PV array and capacity storage) is given at the system configurations with $LCS = 9$ years.

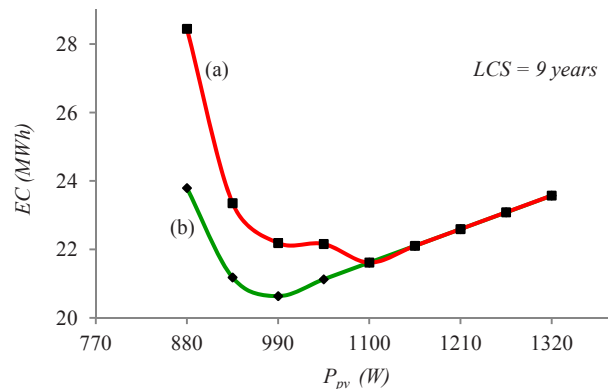

Fig. 9. Energetic cost, (a) Without load management; (b) With load management

According to the results, the load management reduced really the energetic cost of PV system. For example, the Fig. 9 shows that the interest of management takes effect at P_{pv} less than 1100 W. Beyond this value, the effect of the load management is neutral.

5. Conclusion

In this paper, an optimal sizing model is developed to optimize the capacity sizes of PV array and storage capacity of a stand-alone photovoltaic system (SAPS) with load management and without extra. The recommended model consists of three parts: the model of the SAPS, the developed model of load management and the models of optimization criteria according to the loss of power supply probability (LPSP) concept for system reliability evaluation and the energetic cost for system economic evaluation. Considering the desired $LPSP$, a set of configurations can be obtained by using the LPSP technique. The configuration with of low EC gives the optimal one.

A case study was conducted to optimize the size of an SAPS, which is intended to remote and scattered housings in Ghardaia site, Algeria. The input data set consists of solar irradiation on the sloped plane at 32° , the developed load profile, as well as ambient temperature recorded with a step of 5 minutes. The stand-alone PV system with load management is simulated by running the developed program. The relations between system reliability and system configurations have been studied. The optimal

configurations of the SAPS are determined in terms of desired system reliability requirements (*LPSP*) and the energetic cost (*EC*).

The suggested load management strategy contributes really to the reduction of storage use. Consequently, this strategy has resulted in the minimization of the number of the batteries replacements and the improvement the performance of SAPS, such as the minimization of the loss of power supply probability (*LPSP*). As a result, this load management offered a double advantage: reducing the energetic cost and enhancing the reliability of PV system.

Acknowledgements

The author would like to thank all the staff of the Grenoble Electrical Engineering Laboratory (France) for providing materials and the computers facilities for achieving the present work. Also many thanks to my colleagues from the PV solar energy department especially Mr Kamel Abdeladim.

References

- [1] BP Statistical Review of World Energy, June 2012.
- [2] Hadj Arab A, Ait Driss B, Amimeur R, Lorenzo E. Photovoltaic systems sizing for Algeria. *Solar Energy*, 1995;2:99-104.
- [3] Hadj Arab A, Chenlo F, Benghanem M. Loss-of-load probability of photovoltaic water pumping systems. *Solar Energy*, 2004;76:713–723.
- [4] Arun P, Banerjee R, Bandyopadhyay S. Optimum sizing of photovoltaic battery systems incorporating uncertainty through design space approach. *Solar Energy* 2009; 83(7):1013-1025.
- [5] Kaldellis JK, Zafirakis D, Kondili E. Optimum sizing of photovoltaic-energy storage systems for autonomous small islands. *International Journal of Electr Power Energy Syst* 2010;32(1):24-36.
- [6] Thiaux Y, Seigneurbieux J, Multon B, Ahmed HB. Load profile impact on the gross energy requirement of stand-alone photovoltaic systems. *Renew Energy* 2010;35(3): 602-613.
- [7] Ali Khodja M. Sauvegarde des tissus anciens à travers la réhabilitation des maisons traditionnelles cas de la vallée du M'Zab. In: International Conference on Medina, Tlemcen, Algeria, 13-14 May; 2008.
- [8] Semaoui S, Hadj Arab A, Azoui B, Hadj Mahammed I, Bakelli Y. Etude d'un système PV autonome destiné à l'électrification d'un village au sud. National Colloquy on Solar Energy, Bejaia, Algeria, 29–30 November; 2006.
- [9] Vengatesh RP, Rajan SE. Investigation of cloudless solar radiation with PV module employing Matlab–Simulink. *Solar Energy* 2011, 85: 1727–1734.
- [10] Hansen AD, Sørensen P, Hansen LH. Models for a Stand-Alone PV System. National Laboratory, Roskilde; ISBN: 87-550-2774-1, December 2000.
- [11] Liang Tsai H, Siang Tu C, Jie Su Y. Development of Generalized Photovoltaic Model Using MATLAB / SIMULINK. The World Congress on Engineering and Computer Science, San Francisco, USA, October 22 - 24, 2008.
- [12] Huang BJ, Hsu PC, Wu MS, Ho PY. System dynamic model and charging control of lead-acid battery for stand-alone solar PV system. *Solar Energy* 2010;84(5):822-830.
- [13] Duryea S, Syed I, Lawrance W. A battery management system for stand-alone photovoltaic energy systems. *IEEE Industry Applications Magazine* 2001;67-72.
- [14] Cherif A, Jraidi M, Dhoubi A. A battery ageing model used in stand-alone PV systems. *Journal of Power Sources* 2002;112(1):49-53.
- [15] Gergaud O, Robin G, Multon B, Ben Ahmed H. Energy modeling of a lead-acid battery within hybrid wind / photovoltaic systems. *EPE - Toulouse*, ISBN:90-75815-07-7, 2003; 1-10.
- [16] Achaïbou N, Haddadi M, Malek A. Lead acid batteries simulation including experimental validation. *Journal of Power Sources* 2008;185:1484-1491.
- [17] Riffonneau Y, Bacha S, Barruel F, Ploix S. Optimal power flow management for grid connected PV systems with batteries. *Sustain Energy, IEEE Transactions* 2011;2(3): 309-320.
- [18] Gergaud O, Multon B, Ben Ahmed H. Analysis and Experimental Validation of Various Photovoltaic System Models. 7th International ELECTRIMACS Congress; Montréal, august; 2002.
- [19] Bakelli Y, Hadj Arab A, Azoui B. Optimal sizing of photovoltaic pumping system with water tank storage using LPSP concept. *Solar Energy* 2011;85(2):288-294.
- [20] Alsema EA, Nieuwlaar E. Energy viability of photovoltaic systems. *Energy Policy* 2000;28.
- [21] Rydh CJ, Sande'n BA. Energy analysis of batteries in photovoltaic systems. Part I: performance and energy requirement. *Energy Conversion and Management* 2004;46.