

Ministry of Higher Education and Scientific Research
Akli Mohand Oulhadj University - Bouira
Faculty of Sciences and Applied Sciences
Computer Science department



Master Thesis

Domain : mathematics and computer science

Sector : computer science

Option : ISIL

Theme

Energy-Efficient Hierarchical Routing Protocol for
wireless sensor networks

- Supervised by :

Dr. ABBAS Akli

- Realized by :

YAHOUI Soheib

06-03-2024

Acknowledgement

In the name of God, the Most Merciful, and may prayers and peace be upon the most honorable of messengers, Muhammad El-Amin, peace and peace be upon him.

To Begin with i have to thank god for blessing me to finish this work . and my sincere greeting to all those who has contributed in this work .

I would like to thank my supervisor Dr ABBAS Akli for bringing his weight considerable experience to this project and simplify for me all the work .

I also extend my gratitude to my parents , my friends and all my family for their support and help all the way.

Thank you all

Abstract

Nowadays, the major problem in the world of wireless sensor networks (WSN) is the energy, they quickly run out of power. In this study we aim to prolong WSN battery lifetime by proposing a new hierarchical routing protocol which minimise the nodes energy consumption by implementing the multi-hop communication to the base station after dividing the network into circular layers to produce a useful system that preserves node energy and maximizes network longevity as a whole. We have obtained results that demonstrate its effectiveness in extending the network lifetime and increasing the amount of data forwarded to the Base station when compared to LEACH protocol.

Keywords : WSN , LEACH , hierarchical routing protocol.

بِسْمِ اللَّهِ الرَّحْمَنِ الرَّحِيمِ
تَلْخِص

فِي الْوَقْتِ الْحَاضِرِ، الْمَشْكِلةُ الرَّئِيسِيَّةُ فِي عَالَمِ شَبَكَاتِ الْإِسْتِشْعَارِ الْأَسْلِكِيَّةِ (ش ا ل) هِيَ الطَّاقَةُ، بَطَارِيئُهَا تَنْفُذُ بِسُرْعَةٍ. فِي هَاتِهِ الدِّرَاسَةِ نَهْدُفُ إِلَى إِطَالَةِ عُمُرِ الشَّبَكَاتِ الْأَسْلِكِيَّةِ مِنْ خِلَالِ إِقْتِرَاحِ بُرُوتُكُولِ تَوْجِيهِ هَرَمِي جَدِيدٍ يُقَلِّلُ مِنْ إِسْتِهْلَاكِ الْأَقْطِ لِلطَّاقَةِ عَنْ طَرِيقِ تَطْبِيقِ الْإِتِّصَالَاتِ مُتَعَدِّدَةِ الْقَفْرَاتِ إِلَى الْمَحْطَةِ الْأَسَاسِيَّةِ بَعْدَ تَقْسِيمِ الشَّبَكَةِ إِلَى طَبَقَاتٍ دَائِرِيَّةٍ لِأَنْتَاجِ نِظَامٍ مُفِيدٍ يُحَافِظُ عَلَى طَاقَةِ الْمُسْتَشْعِرِ وَيَزِيدُ مِنْ طُولِ عُمُرِ الشَّبَكَةِ كُلِّهَا. وَقَدْ حَصَلْنَا عَلَى نَتَائِجٍ تُثَبِّتُ فَعَالِيَّتَهُ فِي إِطَالَةِ عُمُرِ الشَّبَكَةِ وَزِيَادَتِ كَمِيَّةِ الْبَيِّنَاتِ الْمُرْسَلَةِ إِلَى الْمَحْطَةِ الْأَسَاسِيَّةِ بِالمُقَارَنَةِ مَعَ بُرُوتُكُولِ لِيْتِشِ.
الْكَلِمَاتُ الْمِفْتَاحِيَّةُ : شَبَكَاتِ الْإِسْتِشْعَارِ الْأَسْلِكِيَّةِ (ش ا ل) ، لِيْتِشِ ، بُرُوتُكُولِ التَّوْجِيهِ الْهَرَمِيِّ.

Contents

1	General overview of wireless sensor networks	3
1.1	Introduction	3
1.2	Sensor	3
1.2.1	Definition	3
1.2.2	Sensor architecture	4
1.3	Wireless sensor networks	5
1.3.1	Definition	5
1.3.2	Architecture of WSN	5
1.3.3	Characteristics of WSN	6
1.3.4	Challenges In WSN	7
1.3.5	Types of wireless sensor networks	9
1.3.6	Application of wireless sensor networks	12
1.3.7	Advantages and disadvantages of WSN	14
1.4	Conclusion	15
2	Routing and clustering in wireless sensor networks	16
2.1	Introduction	17
2.2	Clustering in WSN	17
2.2.1	Terms	17
2.2.2	Clustering features and attribute	18
2.2.3	Clustering characteristic	19
2.3	Routing protocols in WSN	20
2.3.1	Data centric routing	20
2.3.2	Hierarchical routing	21
2.3.3	Location based routing	22
2.4	LEACH	22
2.4.1	LEACH characteristics	23
2.4.2	LEACH drawbacks	23
2.5	PEGASIS	23
2.5.1	PEGASIS characteristics	24
2.5.2	PEGASIS drawbacks	24
2.6	TEEN	25
2.6.1	TEEN features	25
2.6.2	TEEN drawbacks	26
2.7	HEED	26
2.7.1	HEED features	27

2.7.2	HEED drawbacks	27
2.8	Comparison table	27
2.9	Conclusion	28
3	The Proposed Approach	29
3.1	Introduction	30
3.2	General description of the proposed approach	31
3.2.1	Work assumptions	32
3.2.2	Energy model	32
3.3	Detailed description	33
3.3.1	Configuration phase	33
3.3.2	Data transmission phase	38
3.3.3	Clusters maintenance phase	38
3.3.4	Sequence diagram	39
3.4	Conclusion	40
4	Simulations and results	41
4.1	Introduction	42
4.2	Simulation resources	42
4.2.1	Software resources	42
4.2.2	Hardware tools	42
4.3	Network model	42
4.4	Simulation	43
4.4.1	Network parameters	43
4.4.2	parameters of the node	43
4.4.3	Energy-related parameters	43
4.4.4	Nodes deploying	44
4.4.5	Packets transmission	45
4.5	Results and discussions	45
4.5.1	Alive nodes	45
4.5.2	Energy levels	46
4.5.3	Data delivery to BS	47
4.6	Conclusion	48

List of Figures

1.1	Sensor	3
1.2	Sensor components	4
1.3	A model of wireless sensor network [1]	5
1.4	Terrestrial WSN [2]	9
1.5	Underwater Wsn [3].	10
1.6	Underground WSN [4].	10
1.7	Multimedia Application [5].	11
1.8	Mobile WSNs [6].	11
1.9	Military application[3].	12
1.10	Home application[7].	13
1.11	Health applications.	13
1.12	Agricultural applications[8].	14
2.1	Cluster components [9].	18
2.2	Routing protocols in WSN[10].	20
2.3	Data centric protocols structure[10].	21
2.4	Hierarchical protocols structure[3].	21
2.5	Location-based protocols structure	22
2.6	LEACH structure [11].	23
2.7	PEGASIS chain[12].	24
2.8	TEEN protocol topology [3].	25
2.9	HEED structure [13].	27
3.1	Multiple circular levels architecture.	30
3.2	Network topology.	31
3.3	Energy model [14].	33
3.4	k-means clustering steps[15].	34
3.5	k-means process for network clustering	35
3.6	Sequence diagram	40
4.1	MATLAB icon. [16]	42
4.2	Nodes deploying.	44
4.3	Packets transmission.	45
4.4	Alive nodes.	46
4.5	Energy consumption level.	46
4.6	Remaining energy level.	47
4.7	Packets delivery.	47

List of Tables

2.1	Protocols comparison table	28
4.1	Network parameters.	43
4.2	Node parameters.	43
4.3	Energy parameters.	44

List of Algorithms

1	Clusters construction algorithm	37
---	---	----

General introduction

Nowadays, rapid advances in technology have established a close connection between computer science and electronics. In this mutually beneficial interaction, wireless and electronic technology is the largest and most powerful industry that provides good quality at a low cost. One of the most promising products of this cooperation is a Wireless Sensor Network .

WSN can simplify people's lives by automating many routine processes. Keeping in mind the evolutionary path attained by the field of wireless sensor networks, there are challenges that researchers and users are working to conquer. Energy conservation, network expansion, and increased reliability and security of data are also among these challenges.

WSNs are getting closer to improving as novel solutions, pioneering communication protocols, and cutting-edge algorithms are being refined. These frontiers and other WSNs might become interdisciplinary as they merge with new technological ideas such as the Internet of Things and Artificial Intelligence .

Clustering in WSN is an efficient method for organizing the network to benefit communication and data management. The clustering in WSNs intends to achieve energy efficiency, mitigate from hot-spots , and enhance network lifetime.

The primary goal of this study is to introduce an innovative hierarchical routing protocol that address the challenges of energy consumption. The proposed methodology uses K-MEANS machine learning to create clusters within each layer of the wireless network. the clusters will be grouped in a shape of circle all the way around the base station with different levels in order to minimise the load on the cluster-heads (CHs) of the lower levels.

Our projects are organized as follows:

- **Chapter 1** : Overview Of Wireless Sensor Networks(WSN).
- **Chapter 2** : Routing and Clustering in Wireless Sensor Networks (WSN).
- **Chapter 3** :The Proposed Approach .

- **Chapter 4** : The results of simulations that have been conducted to evaluate the functionality of our approach compared to LEACH protocol.

General overview of wireless sensor networks

1.1 Introduction

Today , The development of technology has provided a unique opportunity for computer science and electronics to form a symbiosis. Because of its great efficiency and inexpensive cost, wireless sensor networks are one of the most widespread and well-liked fields. One of the most significant technologies that improves our quality of life is WSN. , which can be used in many fields like agriculture , industrial and military[17].

In this chapter we discuss about WSNs in general and how they function , The architecture , the topology and how can they form a network .

1.2 Sensor

1.2.1 Definition

A sensor is an apparatus that receives input from the external world and processes it. Light, heat, motion, moisture, and pressure are examples of inputs. The output is generally a signal that is converted to a human-readable display at the sensor location or transmitted electronically over a network for reading or further processing[17].

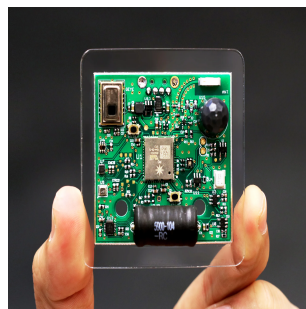

Figure 1.1: Sensor

1.2.2 Sensor architecture

Typically, a wireless sensor node consists of 4 main units[18]:

- Processing unit
- Sensing unit
- Power unit
- Communication unit

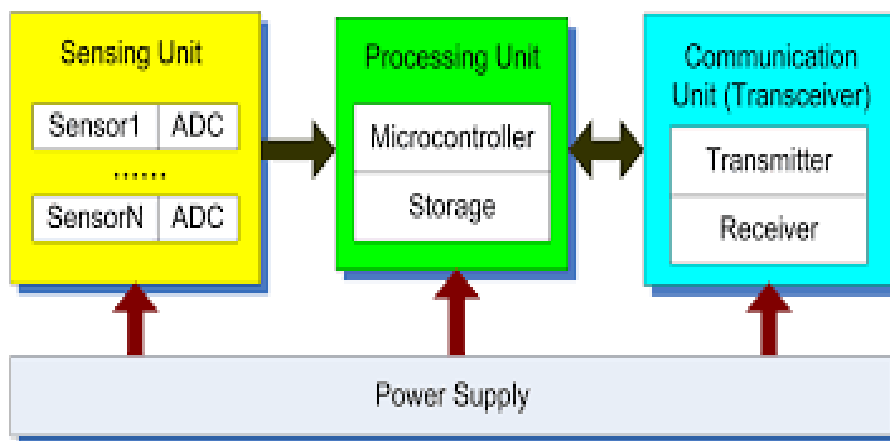

Figure 1.2: Sensor components

A) The unit of processing

The processing unit begins its execution in the system software as cooperating with sensing units after receiving information or data from sensor nodes. Additionally, it engages in communication [18].

B) The power supply

Sensors consume energy for a variety of purposes, including data processing and environmental monitoring. Power units supply power to sensor nodes. It is a sensor node's basic power source [18].

C) The unit of sensing

Sensing units are a feature of any sensor device. Typically, it is separated into two sub-units: the analog-to-digital portion and the sensors section. The sensor portion is made up of microphones, cameras, and video. Sensor nodes produce analog signals, which software subsequently transforms into digital signals and sends to a processing unit. [18].

D) Communication unit

Communication software facilitates transmission and reception through a communication unit, which is a subsystem that stabilizes the interface between a de-

vice and the network [18].

1.3 Wireless sensor networks

1.3.1 Definition

A wireless sensor network (WSN) is a self-organized wireless network that comprises independent sensor nodes distributed throughout a given space capable of performing sensor-based activities, computation, and communication[19].

1.3.2 Architecture of WSN

Wireless sensor networks usually consists of a large number of nodes called sensor node that bring themselves together to form a wireless network. These sensor nodes are scattered in sensor field situated far from the user which consist of sensor nodes, cluster-heads (CHs) , Base station (BS) and monitored events[20].

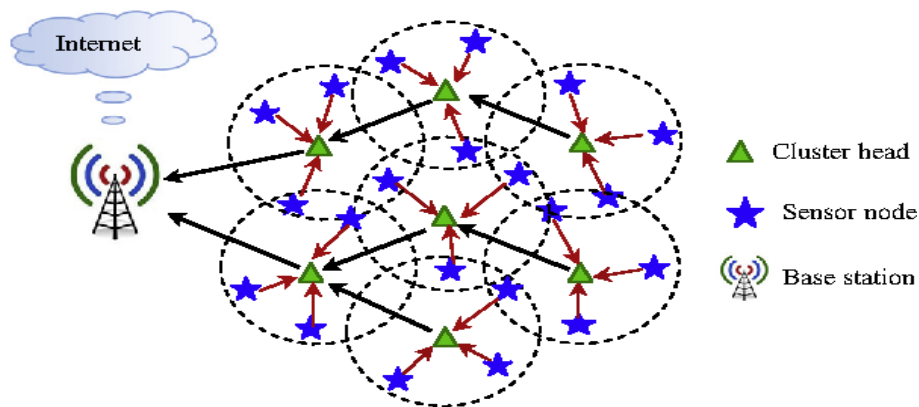

Figure 1.3: A model of wireless sensor network [1]

1.3.3 Characteristics of WSN

A) Power efficiency

The optimization of energy consumption is a critical aspect of the design process. In a wireless sensor network, a device possesses the capability to dynamically alter its transmission pathway and assume managerial control over all the participating nodes. The intended functionality of the system is predicated upon compatibility with non-direct energy sources[21].

B) Fault tolerance

The wireless sensor nodes have ability of organizing itself in the network as nodes have deployed in random fashion remote location and unreceptive environment. For preventing from fault sensor nodes have worked in collaboration to reorganize itself and used distributed algorithm to form network automatically [22].

C) Scalability

The importance of scalability cannot be overstated when considering the deployment of large-scale sensor networks. Within wireless sensor networks (WSNs), the nodes are intricately and densely distributed. Hence, Wireless Sensor Networks (WSN) must exhibit the characteristic of scalability to effectively manage a considerable quantity of network nodes[23].

D) Responsiveness

A WSN should be able to quickly adapt to changing topologies of connected sensor nodes[23].

E) Mobility of nodes

The attribute of nodes being mobile is regarded as a coveted characteristic in network systems. Specifically, certain nodes require mobility to enhance communication efficacy or to accommodate the demands of various applications[23].

F) Heterogeneity of nodes

However, node heterogeneity is viewed from an energy perspective, so the nodes that have high energy levels are considered Cluster Heads . On the other hand, other nodes, which have the same levels of energy as the Cluster Heads, are put in their sleep mode. These gadgets are called backup nodes[23].

1.3.4 Challenges In WSN

The following characteristics of sensor networks must be taken into account by the clustering protocols :

A) Energy

Energy efficiency is the initial, and frequently most significant, design problem for a WSN. The three functional areas of data processing, communication, and sensing may be used to categorize power usage , each has to be optimized. The lifespan of the sensor node usually shows a high correlation with the battery life. The most common limitation in sensor network architecture is the restricted energy budgets that sensor nodes have [3].

B) Limited memory and storage space

A sensor with limited memory and code space is inherently built-in. Developing a robust security mechanism for such a device requires strict constraints on the size of cryptographic algorithms' code. For instance, a commonly used type of sensor may feature a 16-bit, 8MHz RISC CPU with only 10K of RAM, 48K of program memory, and 1024K of flash. Due to these constraints, the software designed for the sensor must have a small footprint[3].

C) Limited bandwidth

Processing data in wireless sensor networks uses a lot less energy than transmitting it. Currently, wireless communication can only transfer data at speeds between 10 and 100 Kbits per second. Sensor message exchanges are directly impacted by bandwidth constraints, and synchronization is not feasible without them. These wireless networks can function in the optical, infrared, or radio spectrums [3].

D) Deployment

Node deployment stands as a critical challenge within Wireless Sensor Networks. A well-designed deployment scheme holds the potential to streamline problem complexity. Managing a substantial number of nodes within a confined environment demands specialized techniques. A sensor region might witness the deployment of hundreds to thousands of sensors. Presently, two deployment models prevail: static deployment and dynamic deployment. In static deployment, optimal locations are selected based on optimization strategies, with no changes to the sensor nodes' positions throughout the WSN's lifespan. Conversely, dynamic deployment involves randomly distributing nodes for optimization purposes[3].

E) Node costs

Numerous sensor nodes make up a sensor network. Therefore, a node's cost plays a crucial role in the sensor network's total financial measure. It is obvious that for the global metrics to be acceptable, each sensor node's cost must be maintained low. Users will find sensor networks more successful and acceptable if the entire cost is reasonable, which requires careful analysis

[3].

F) Fault tolerance

Ensuring uninterrupted operation of the sensor network despite node failures is important. The network must adapt and adjust its connectivity in real-time to address unforeseen failures or malfunctions. Effective deployment of routing algorithms is essential in re-configuring the network's overall architecture to maintain functionality[3].

G) Design constraints

The central objective of wireless sensor design is to develop devices that are smaller, more cost-effective, and operate more efficiently. However, numerous additional challenges can influence the design of sensor nodes and wireless sensor networks (WSNs). These challenges encompass both software and hardware design aspects, characterized by stringent constraints. Security represents a notable concern amidst these challenges [3].

1.3.5 Types of wireless sensor networks

Wireless sensor networks are deployed in various environments, spanning terrestrial, subterranean, and aquatic domains, each presenting unique challenges and constraints. The classification of Wireless Sensor Networks (WSNs) encompasses five main categories: Terrestrial WSNs, Underground WSNs, Underwater WSNs, Multimedia WSNs, and Mobile WSNs, each tailored to specific environmental conditions and operational requirements [2].

A) Terrestrial WSNs

Terrestrial Wireless Sensor Networks (WSNs) are typically composed of an extensive number of low-cost wireless sensor nodes that are positioned within a specific region either through an ad-hoc or pre-arranged methodology. In instances where the sensor nodes are intended for temporary utilization, they may be intentionally deployed by being released from an aircraft and subsequently dispersed haphazardly throughout the desired geographical region [2].

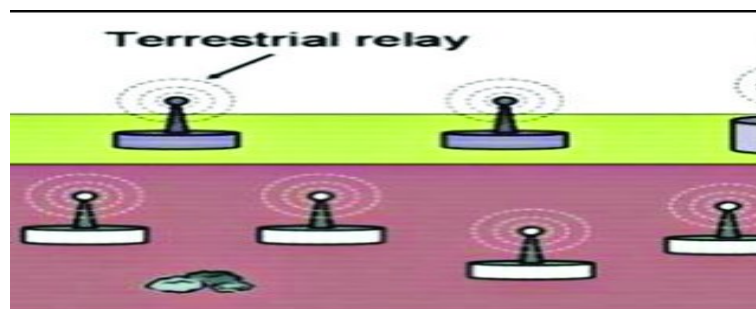

Figure 1.4: Terrestrial WSN [2]

B) Underwater WSNs

Underwater Wireless Sensor Networks (UWSNs) are specialized networks consisting of autonomous underwater sensor nodes equipped with sensing, processing, and communication capabilities, deployed in aquatic environments such as oceans, seas, lakes, and rivers. These networks are designed to enable real-time monitoring, data collection, and communication in underwater environments, allowing for the observation of aquatic ecosystems, oceanographic phenomena, underwater structures, and marine life. UWSNs face unique challenges including limited bandwidth, high propagation delays, harsh environmental conditions, and energy constraints, which necessitate the development of specialized communication protocols, energy-efficient algorithms, and robust underwater sensing technologies[22].

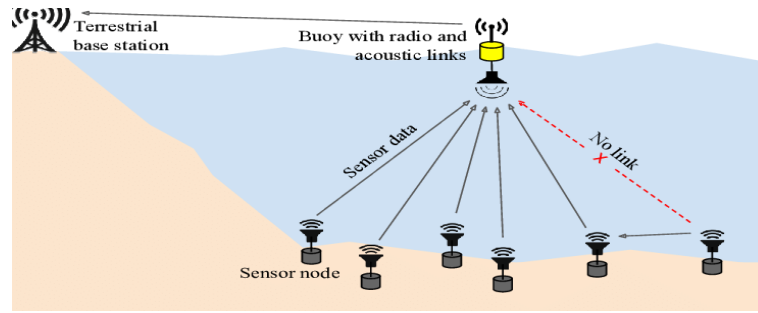

Figure 1.5: Underwater Wsn [3].

C) Underground WSNs

Underground Wireless Sensor Networks (UWSNs) are specialized networks composed of sensor nodes deployed beneath the earth's surface for various applications such as environmental monitoring, infrastructure management, and geological exploration. These networks utilize wireless communication technology to enable data collection, transmission, and coordination among sensor nodes deployed in underground environments, such as tunnels, mines, underground utilities, and soil profiles. UWSNs face unique challenges including limited energy resources, harsh underground conditions, communication constraints due to soil attenuation, and node mobility limitations. Designing effective UWSNs requires the development of specialized communication protocols, energy-efficient algorithms, and robust sensing technologies capable of withstanding the underground environment's challenges while fulfilling the network's intended objectives[2].

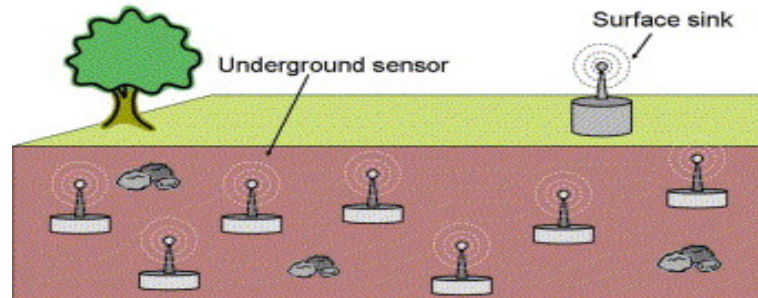

Figure 1.6: Underground WSN [4].

D) Multimedia WSNs

Multimedia Wireless Sensor Networks (MWSNs) are specialized networks that integrate multimedia data, including audio, video, and image streams, alongside traditional sensor data for various applications such as surveillance, environmental monitoring, and multimedia content delivery. These networks enable the collection, transmission, and processing of multimedia data from sensor nodes distributed across different locations. MWSNs face unique challenges compared to traditional WSNs, including higher bandwidth requirements, increased energy

consumption for multimedia data processing and transmission, and stringent quality of service (QoS) constraints for multimedia content delivery. Designing efficient MWSNs involves the development of multimedia-aware communication protocols, energy-efficient multimedia data compression and transmission techniques, and adaptive multimedia data processing algorithms to ensure reliable and timely delivery of multimedia content while optimizing network resources and energy consumption [22].

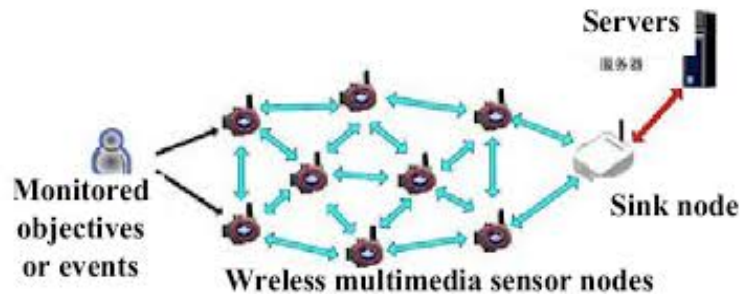

Figure 1.7: Multimedia Application [5].

E) Mobile WSNs

Mobile Wireless Sensor Networks (MWSNs) are networks of sensor nodes equipped with mobility capabilities, enabling them to change locations as needed. These networks are employed in various applications like environmental monitoring and surveillance, where dynamic data collection is essential. Unlike traditional sensor networks, MWSNs offer flexibility in node placement, allowing for real-time adjustments to changing environmental conditions. Challenges in MWSNs include efficient routing in dynamic environments, managing node movement, and preserving energy resources. Successful MWSN design involves developing communication protocols and routing algorithms that account for node mobility while ensuring reliable data transmission and energy efficiency [2].

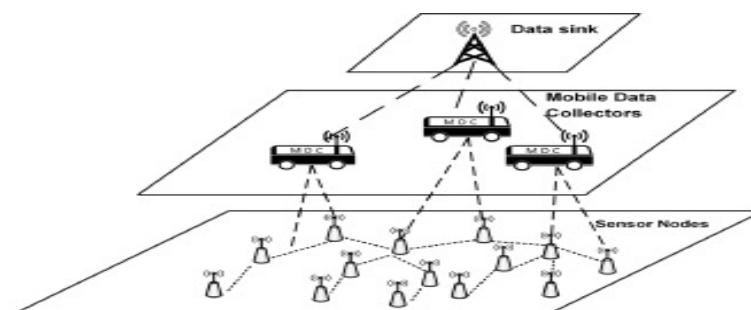

Figure 1.8: Mobile WSNs [6].

1.3.6 Application of wireless sensor networks

A) Military applications

Military command, control, communications, and intelligence systems are increasingly reliant on WSNs. On the battlefield, sensors may be used to track and detect the presence of vehicles and soldiers, enabling near observation of the enemy.

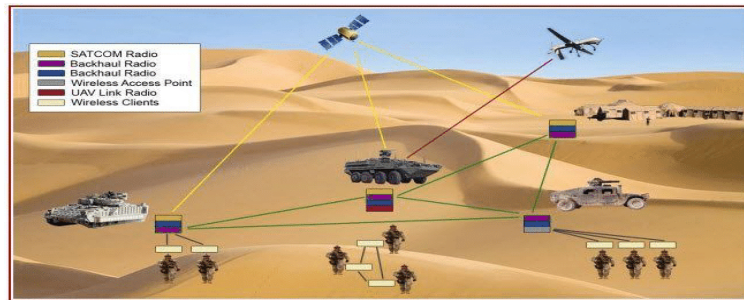

Figure 1.9: Military application[3].

B) Home applications

Wireless Sensor Networks (WSNs) have found numerous applications within home environments, revolutionizing the way we interact with and manage our living spaces. From enhancing convenience to ensuring safety and optimizing energy usage, WSNs play a pivotal role in modern homes. These networks enable home automation by intelligently controlling lighting, heating, and other appliances based on occupancy and environmental conditions. Additionally, WSNs serve as a robust security solution, with sensors detecting intrusions and sending timely alerts to homeowners. They also facilitate environmental monitoring by tracking indoor air quality, temperature, and humidity levels. Furthermore, WSNs contribute to smart energy management, allowing homeowners to monitor and optimize energy consumption. Whether it's ensuring the well-being of occupants, preventing accidents, or simply enhancing comfort, WSNs have become indispensable tools for creating efficient and connected home environments[24].

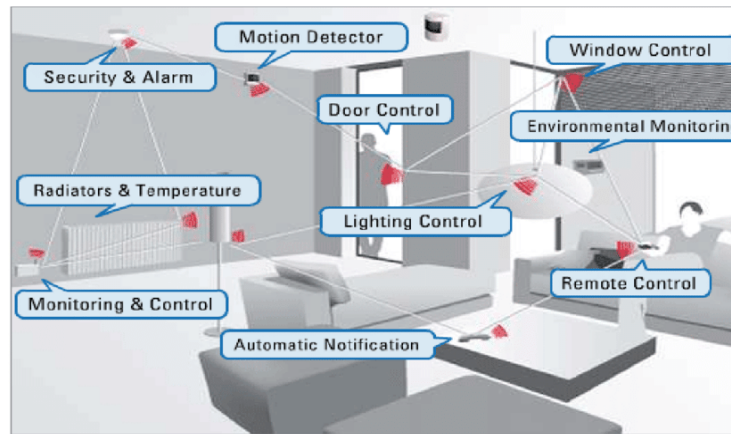

Figure 1.10: Home application[7].

C) Health applications

In health care area, modern hospitals nowadays using WSNs to[25]:

- Monitor patient psychological data.
- Control drugs.
- Unconsciousness fall detection .



Figure 1.11: Health applications.

D) Agricultural applications

Wireless sensor network adoption in agriculture reduces complex wiring, improving efficiency in tough conditions. Water tank levels are monitored by pressure transmitters, and pumps are controlled wirelessly. Moreover, wireless transmission enables water usage metering, facilitating prompt data transfer for streamlined monitoring and management[24].

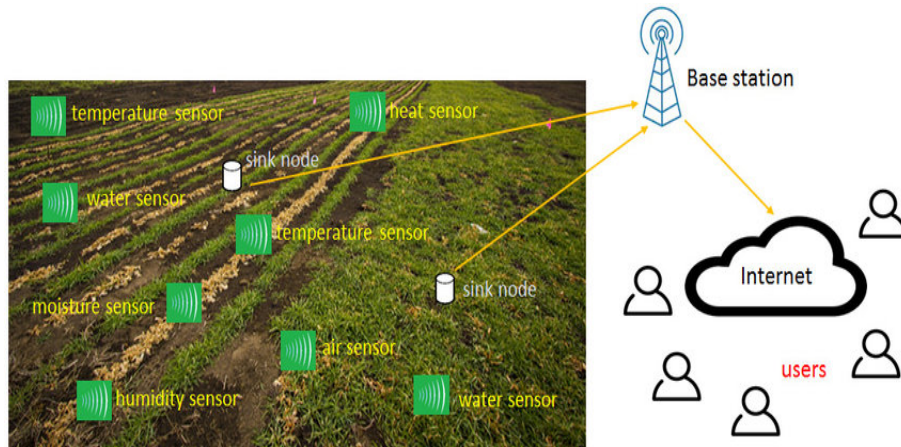

Figure 1.12: Agricultural applications[8].

1.3.7 Advantages and disadvantages of WSN

Advantages

The main advantages of WSNs are the following [24]:

- Inexpensive installation and maintenance cost.
- flexibility and scalability.
- A lot of networking protocols.
- Minimum interference via radio spectrum.
- Might function in hard condition environment.
- Coexistence with other wireless network standards.
- Accuracy of data.

Disadvantages

The main disadvantages of WSNs are the following [24]:

- Limitation on supply power.
- Possibility of data intercepting.
- Potentially expandable system only within the radius of the network.

- The nodes must coordinates between them.
- Time limit in data reception (TDMA).

1.4 Conclusion

In this chapter, we covered the fundamental principles of wireless sensor networks, including their architecture, various applications. Additionally, we explored Protocol Stack of Wireless Sensor Networks . Finally, we delved into real-life applications and advantages of WSNs. Given the critical role of energy management, the next chapter will focus on the clustering techniques and routing concepts in wireless sensor networks and we will introduce LEACH protocol.

Chapter **2**

Routing and clustering in wireless sensor networks

2.1 Introduction

Clustering in Wireless Sensor Networks (WSNs) involves grouping sensor nodes into clusters to optimize energy efficiency and data aggregation. It aims to prolong network lifetime by reducing communication overhead and energy consumption. Cluster heads are elected to manage intra-cluster communication and relay data to the base station. Various algorithms like LEACH and HEED are used for cluster formation based on factors like node energy, distance, and communication cost. Clustering facilitates scalable and efficient data gathering in WSNs, essential for applications like environmental monitoring and surveillance.

In this chapter we discuss about clustering and routing in wireless sensor networks and introduce some protocols by give a general overview.

2.2 Clustering in WSN

2.2.1 Terms

A) Clustering

A network can be divided into clusters using the clustering technique. Each group selects one of these nodes to be its leader. This node is referred to as the cluster head (CH). The cluster leader communicates with the other group's CH.

B) Cluster

A cluster is an organizational unit within a network made up of several sensor nodes. These networks are so densely packed and grouped together in a way that makes sense in order to streamline communication and address a number of issues.

C) Cluster head (CH)

The task of arranging, coordinating, aggregating, and/or processing the communications and data gathered within the cluster falls to a unique node known as the cluster head (CH). Thanks to a particular metric or set of metrics, that selection is carried out in a deterministic or random manner.

D) Base station (BS)

At the summit of a hierarchical WSN is a base station. It Creates channels of communication between end users and sensor networks.

E) Member node

In a cluster, a member node it is not the cluster leader nor the base station .It is just a simple sensor.

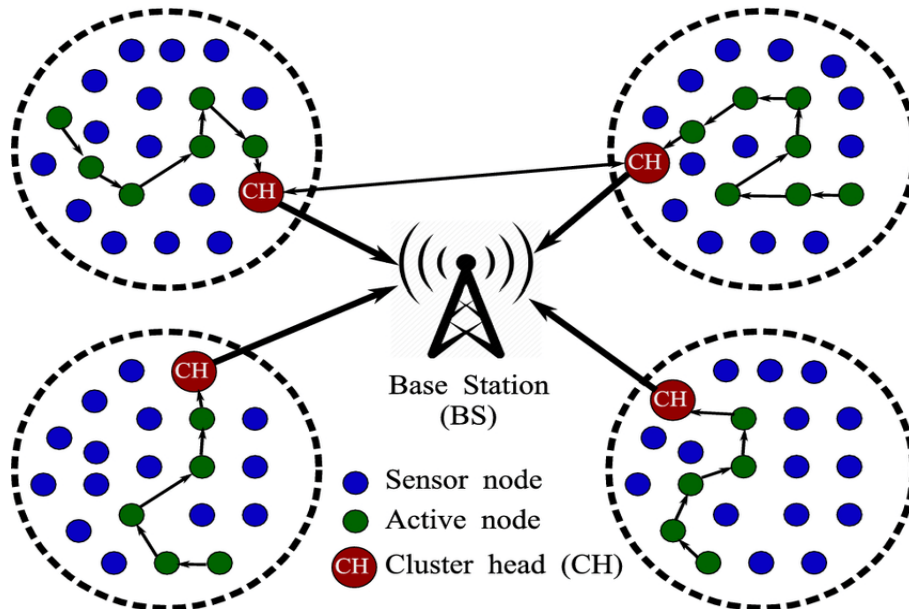

Figure 2.1: Cluster components [9].

2.2.2 Clustering features and attribute

Generally there is 3 main properties to classify clustering mechanism :

- Cluster properties.
- CH properties.
- Clustering process properties.

A) Cluster properties

i) Cluster count :

The number of clusters and the set of CH are predetermined in certain practical approaches. Choosing CHs at random from provisioned nodes usually results a different number of clusters [26].

ii) Clusters communication types:

First is Intra-cluster communication , between the (CHs) and the nodes. This communication usually is directly but it may require a multi-hop communication when the number of cluster head is limited compared to the sensor nodes .

Second is inter-cluster, used to communicate between the CHs and BS in a direct (single-hop) or multi-hop manner. For energy-efficient data transfer multi-hop mechanisms are typically preferred within a large WSN. Single hop transmission is used in certain small-scale WSN applications to communicate between the CH and BS.

B) CH properties

i) Mobility :

Member nodes are impacted by the cluster head node's mobility, which necessitates routine maintenance. In contrast, a fixed cluster head facilitates network management by working to create a stable cluster. Cluster heads, however, may move themselves to enhance network functionality.

ii) Role:

A few of CH's primary responsibilities include merely forwarding traffic and combining or aggregating the data it gathers.

C) Clustering process properties

i) Method :

The two types of clustering techniques are distributed and centralized. While the distributed approach is popular in large WSNs, it might lack a central authority. The centralized approach uses a central authority, such as a BS, to control every aspect of the operation (clustering, CH selection, etc.)[\[26\]](#).

ii) CH selection :

In WSN, there are two approaches available for choosing CH: Deterministic and probabilistic. In the probabilistic method, CH is selected at random and without careful specifications. Meanwhile in the deterministic methods , different metrics are used to choose CHs , such as the residual energy, node degree, node centrality and distance to BS [\[26\]](#).

iii) Complexity of the algorithm :

The complexity may change depending on the quantity of CHs and sensor nodes and the area topology.

2.2.3 Clustering characteristic

A) Data aggregation level

Data aggregation happens either at the cluster head level exclusively or at every network node, depending on the kind of sensor being used. Data aggregation lowers the amount of data that is transferred between nodes, which uses less power. Numerous aggregation methods are employed. That is: Simple functions like the sum, average, and standard deviation, or more intricate ones unique to the application being used.

B) Clusters types

Discrete clusters and connected clusters are the two types of clusters that can be produced by the employed clustering algorithm. A node can only be a part of one cluster at a time in the first type , they are grouped into non-overlapping clusters, meaning that a node belongs to only one cluster. Often used in scenarios where nodes need to be deployed into specific separated regions. While in the connected cluster Nodes can be simultaneously a part of one or more clusters.

This type of clustering is suitable for scenarios where nodes need to collaborate on multiple tasks or cover overlapping zones.

2.3 Routing protocols in WSN

Based on distinct design elements and needs for various applications, the routing protocol for sensor networks can be separated into three groups [27]:

- Data centric
- Hierarchical
- Location based

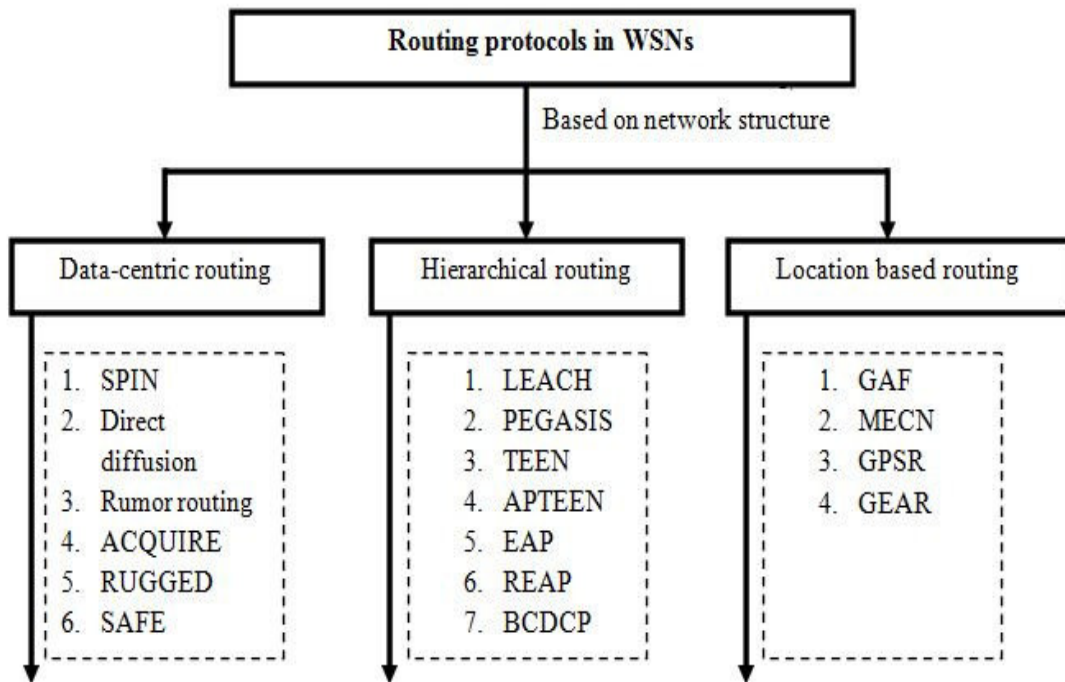

Figure 2.2: Routing protocols in WSN[10].

2.3.1 Data centric routing

A data-centric protocol in Wireless Sensor Networks (WSNs) is designed to handle sensor data efficiently by focusing on aggregation and optimized routing. These protocols aggregate similar data to minimize transmission and conserve energy. They use routing algorithms based on data content rather than node identities or distance alone, optimizing bandwidth and extending node lifespan. They also support efficient data querying for real-time monitoring in applications like environmental monitoring and industrial automation.

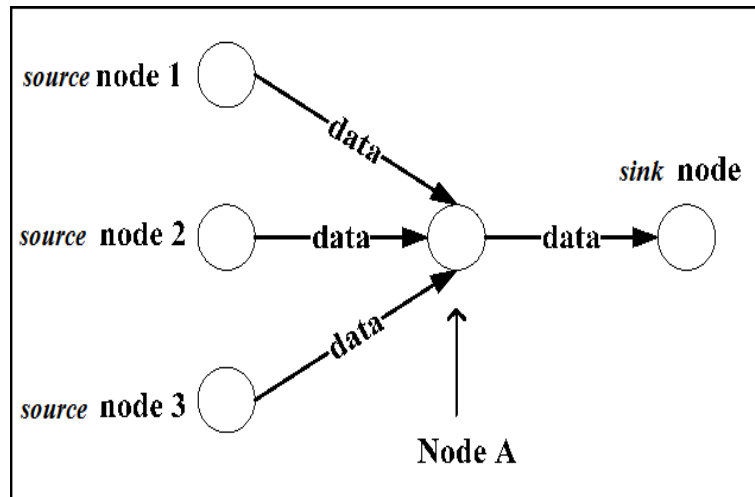

Figure 2.3: Data centric protocols structure[10].

2.3.2 Hierarchical routing

A single tier network cannot provide all of the functionalities instantly as the network expands. In certain routing techniques, clustering is introduced to cover a large area with wireless sensor networks. The primary goal of hierarchical routing is to effectively manage the energy consumption of sensor nodes by utilizing data aggregation and fusion to reduce the amount of transmitted messages to the sink and by integrating them in multi-hop communication [27].

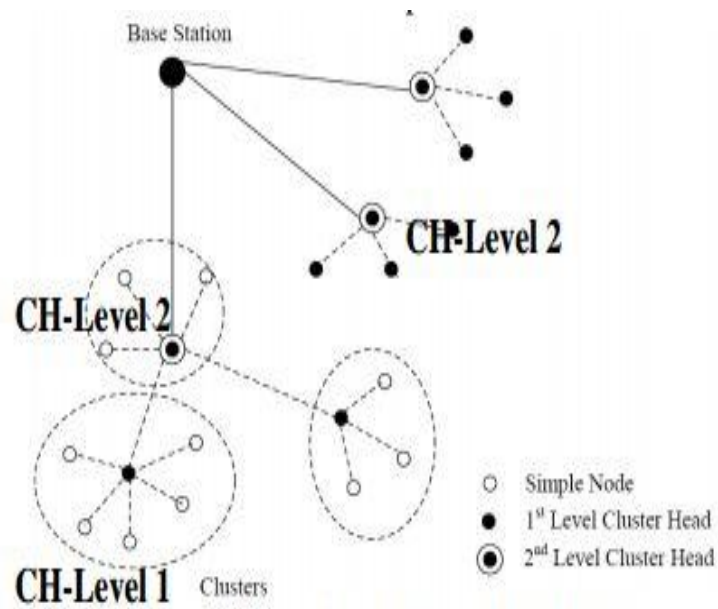

Figure 2.4: Hierarchical protocols structure[3].

2.3.3 Location based routing

Numerous energy-conscious routing protocols rely on the sensor node's location. For the purpose of energy consumption management, they calculate the distance between two nodes. Knowing the distances between nodes allows a query to be distributed only to that specific unit, greatly reducing the amount of transmissions. We refer to these routing protocols as location-based routing protocols [27].

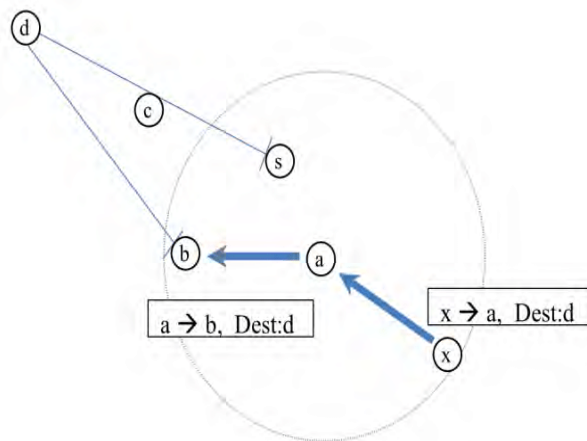

Figure 2.5: Location-based protocols structure

2.4 LEACH

Low energy adaptive clustering hierarchy protocol (LEACH) is a type of cluster-based routing protocol that facilitates distributed cluster formation. It operates by randomly choosing a subset of sensor nodes as cluster heads (CHs) and periodically rotates these roles to distribute energy consumption evenly across the network. The protocol employs local CHs as routers to the sink. Within LEACH the CHs nodes compress data from their respective clusters then transmit aggregated packets to the Base Station (BS) to minimize the volume of data transmitted. LEACH utilizes a TDMA/CDMA MAC protocol To mitigate collisions and reducing both inter-cluster and intra-cluster conflicts. Data processing tasks such as fusion and aggregation occur locally within each cluster head[22].

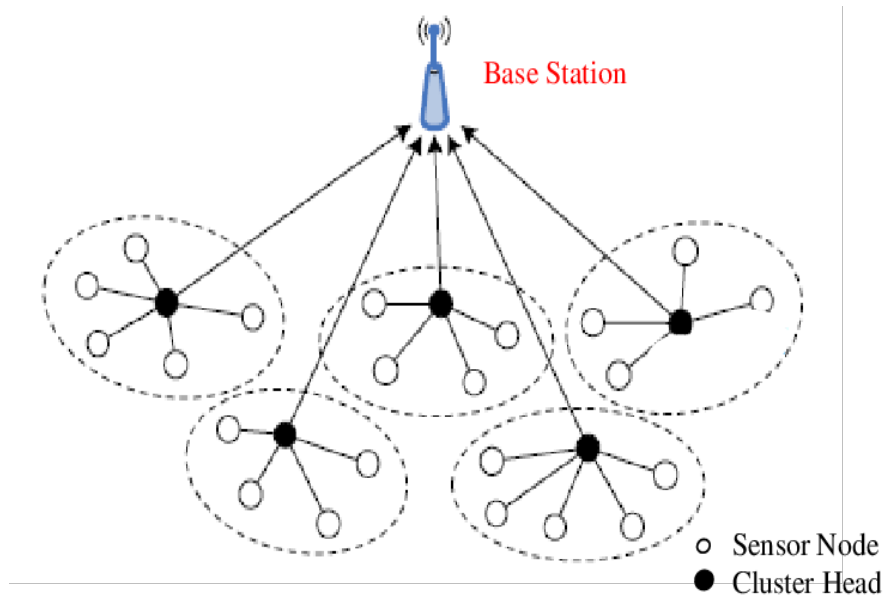

Figure 2.6: LEACH structure [11].

2.4.1 LEACH characteristics

The following are LEACH protocol main features[20]:

- To achieve balanced energy consumption, it randomly rotates the cluster head role.
- Sensors don't require knowledge of distance or location.

2.4.2 LEACH drawbacks

There are some drawbacks of this protocol such as [20] :

- LEACH employs single-hop routing, enabling direct transmission between every node and the cluster head and sink. As such, it does not apply to networks that are spread across large areas.
- CHs are elected at random, therefore there's a chance that they'll all be centered in the same place.
- In each CH election round, the protocol assumes that all nodes have the same initial energy capacity and that each node's energy consumption is roughly equal.

2.5 PEGASIS

Power-Efficient Gathering in Sensor Information Systems (PEGASIS) , a near-optimal chain-based protocol that is an improvement over the LEACH protocol. The fundamental concept of the protocol is that nodes only need to communicate with their nearest neighbors in order to prolong network lifetime, and they communicate with the BS in turn.

A new round begins when all nodes have finished communicating with the BS, and so on. The nodes that are closest to each other create a path to the base station and this called a chain in PEGASIS. Any node in the chain may send the

aggregated form of the data to the BS. The nodes in the chain will send to the BS alternately. Each node in PEGASIS uses the signal strength to calculate the distance to all of its neighbors in order to determine which one is closest. It then modifies the signal strength so that only that one neighbor node is audible[20].

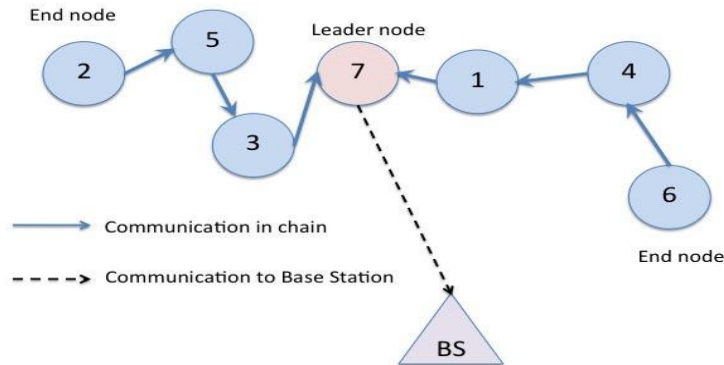

Figure 2.7: PEGASIS chain[12].

PEGASIS uses two strategies to conserve energy [20]:

- The head node can receive a maximum of two data messages.
- There is significantly less distance that the data must travel to reach a one-hop neighbor.

2.5.1 PEGASIS characteristics

The following are this protocol's salient characteristics[20]:

- PEGASIS transmits to the BS using a single node in a chain rather than several nodes, avoiding cluster formation.
- PEGASIS uses cooperative techniques to extend the lifetime of each node.
- Because PEGASIS spreads the power draining evenly across all nodes, it lowers the power needed to transmit data per round.

2.5.2 PEGASIS drawbacks

This protocol has a few shortcomings [20], including :

- Every sensor node is assumed by PEGASIS to be able to speak with the BS directly. Practically , multi-hop communication is used by sensor nodes to connect to the base station.
- PEGASIS operates under the assumption that every sensor node has an identical energy level and will most likely die simultaneously.
- For far-off nodes in the chain, PEGASIS introduces an excessive delay.

2.6 TEEN

TEEN (*threshold sensitive energy efficient sensor network protocol*) is a protocol for clustering in WSN that addresses reactive networks and allows cluster heads to set a time limit for when sensors report the data they have sensed. Every CH broadcasts to its members two values: *hard threshold (H T)*, and *soft threshold (S T)*. The hard threshold (H T) is the value that a sensor should activate its transmitter to report its sensed data to its cluster head if it exceeds this value. Where the soft threshold (S T) helps to adjust the sensitivity of certain parameters based on the network's current conditions, allowing for adaptability in response to changing environmental or network conditions. For example soft threshold might be set to trigger a node to transmit data only when the temperature exceeds a certain level[22].

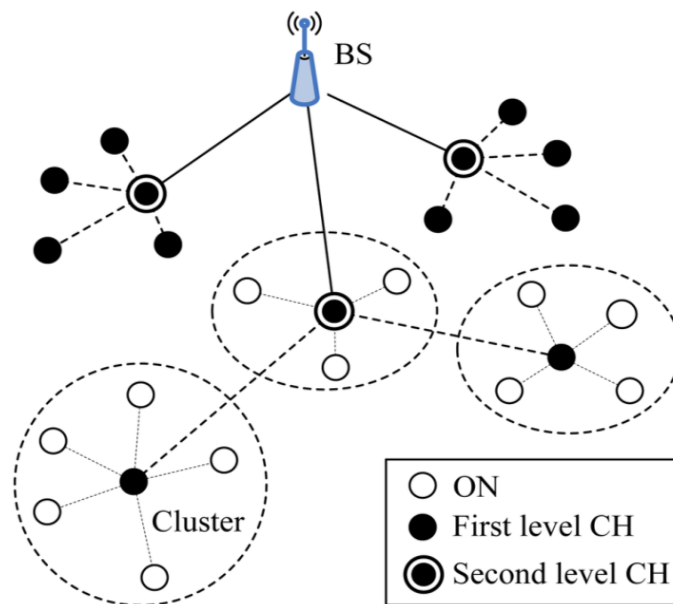

Figure 2.8: TEEN protocol topology [3].

2.6.1 TEEN features

The main features of this protocol are as follows [3]:

- Users almost immediately receive time-sensitive data.
- Depending on the target application and the sensed attribute's criticality, the soft threshold can be adjusted.
- A lower value of the soft threshold results in a more precise representation of the network, but at the cost of higher energy usage.
- The user can modify the attributes as needed because they are broadcast again at each cluster change time.

2.6.2 TEEN drawbacks

The main drawbacks of this protocol are as follows [22]:

- A node may hold off on sending data until its designated time slot. If a node has no data to transmit, time slots may be wasted.
- Cluster heads continuously wait for node data by turning on their transmitter.

2.7 HEED

Hybrid energy-efficient and distributed (HEED) clustering approach was suggested with three main objectives: (1) producing well-distributed cluster heads and compact clusters. (2) ending the clustering process after a fixed number of iterations. and (3) extending network lifetime by distributing energy consumption. A hybrid of two clustering parameters is used by HEED to choose cluster heads on a periodic basis: The residual energy of each sensor node is the primary parameter, and the intracluster communication cost as the secondary parameter. The secondary parameter is used to break ties and the primary parameter is used to probabilistically select an initial set of cluster heads [22]. Each sensor node sets the probability $CHprob$ of becoming a cluster head as follow:

$$CHprob = Cprob * \frac{E_{residual}}{E_{max}} \quad (2.1)$$

where :

- $Cprob$ is the initial probability, a predetermined value.
- $E_{residual}$ is the leftover energy.
- E_{max} is the sensor nodes' maximum energy.

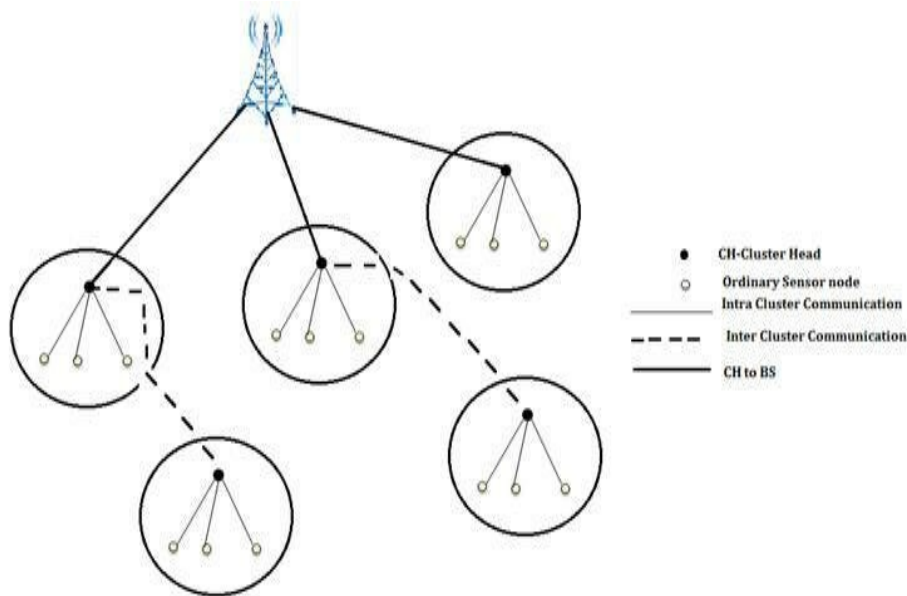

Figure 2.9: HEED structure [13].

2.7.1 HEED features

The main features of this protocol are as follows [28] :

- Suitable for networks with a broad scope.
- The number of iterations required to finish the clustering process can be fixed, and the cluster heads can be dispersed fairly evenly throughout the network.
- Mobility support, Sensor nodes or sinks may be mobile in specific situations.

2.7.2 HEED drawbacks

The main drawbacks of this protocol are as follows [28] :

- There can be no real even distribution of cluster heads in the network using probabilistic cluster head selection techniques.
- A cluster can only be formed through multiple iterations, and each iteration generates overhead by broadcasting numerous packets.
- Premature outages can occur in some cluster heads, particularly those close to sinks, which can result in hot spots in the network .
- Limited adaptability, HEED may lack adaptability to diverse application requirements and network scenarios.
- Limited scalability , HEED might not be able to adjust to different network scenarios and application requirements.

2.8 Comparison table

The next table provides a summary of the comparison between the protocols that were listed below

Protocol	Classification	Energy efficiency	Scalability	Advantages	Disadvantages
LEACH	Hierarchical	Medium	Low	Low complexity algorithm	Updating the CH without taking account the remaining energy
PEGASIS	Hierarchical	high	Low	Equal distribution of energy conception	excessive delay for far nodes
TEEN	Hierarchical	high	Low	Real-time data transmission to users	not suitable for applications with periodic reports
HEED	Hierarchical	high	Good	Best large-scale networks	lack adaptability

Table 2.1: Protocols comparison table

2.9 Conclusion

After giving a summary of clustering in WSN, we have looked at the idea and characteristics of clustering in WSN. We emphasized that maximizing network life is one of the key advantages of clustering in wireless sensor networks (WSNs). We presented several clustering protocols, such as LEACH, PEGASIS, and others that are employed in WSN. We looked at their tenets, benefits, and drawbacks.

Chapter **3**

The Proposed Approach

3.1 Introduction

In a wireless sensor network (WSN), clustering is a useful organization technique that makes data management and communication easier.

Our proposed clustering method for wireless sensor networks (WSN) is explained in this chapter. This work's primary goal is create a new clustering strategy that maximizes the network energy and service life.

We aims to reduce the number of redundant transmissions by classifying sensor nodes into multiple levels based on how far away they are from the base station. In this case, the network is categorized into a range of circular levels with the Base Station BS serving as the centroid. A three-level sample of the network layout is shown in the next figure :

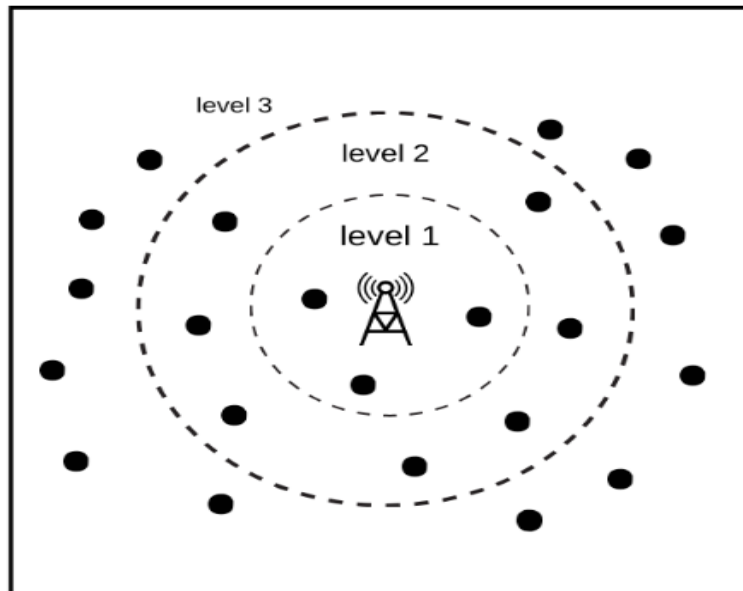

Figure 3.1: Multiple circular levels architecture.

3.2 General description of the proposed approach

In this section, we present a novel low-power hierarchical routing protocol designed for WSN.

The main idea is to divide the network into multi-levels according to the geographical location relative to the Base Station (BS), where the BS is in The centroid. In order to construct clusters we employ the K-means technique for each layer expect the first level (the closest to the BS). The K-means algorithm determines which nodes are closest to the centroid, then it chooses the CH from them.

We avoid clustering in level 1 because of All the nodes are within the BS's radio range. Therefore, these nodes forward their information directly to the BS in order to avoid redundant transmission. Practically it does not help to cluster in that level. A cluster of first level nodes consists of just one CH, or the CH node. The k-MEANS then completes the clustering in the second and third level nodes and so on. The clustering in these levels is separately from each other.

Also this will mitigates from hot-spots by distributing the transmission load and helps load balancing among CHs because we have a maximum number of CH within this level.

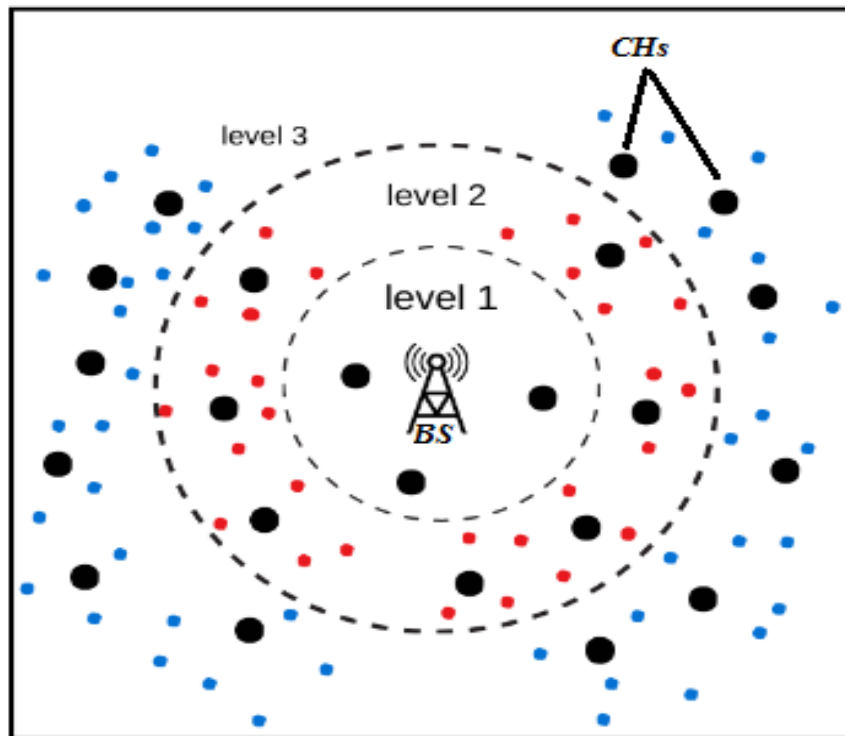

Figure 3.2: Network topology.

3.2.1 Work assumptions

The BS is in charge of carrying out node clustering, designating roles to the nodes, and choosing the best path for data transmission. Since the BS is typically thought to be distinct from sensor nodes, it is not constrained in terms of energy or processing capacity. All of the sensor nodes that are dispersed throughout the network are assumed to have the same maximum radio range. The radio range shows the maximum distance over which any node can send electromagnetic waves carrying data.

Based on the routing protocol policies and the priorities of each cluster, the BS node assigns the CH role to a sensor node. The CH is responsible for gathering data from the cluster nodes and removing unnecessary data, putting it all together, and sending it as a single packet. As a result, every calculation is carried out inside the BS. Because of this, the BS node is sufficiently aware of the nodes' locations and energy levels. Time Division Multiple Access (TDMA) tables are created by the BS and forwarded to all CH nodes.

Actually, sensor nodes use time division multiple access (TDMA) to schedule data transmission, allowing the nodes to store energy and turn off their radio antennas until their designated transmitting time slot.

3.2.2 Energy model

Every routing round's energy usage is computed with respect to the packet transmission path. The CH receives the sensing data from the regular nodes. Then removes superfluous data and aggregates the received data using certain procedures. This would result in a significant decrease in the quantity of packets transmitted over the network and a decrease in energy consumption. The information is aggregated, then packetized and sent to the BS [14]. Power consumption (E_c) of sensor nodes is determined by the following formula[14]:

$$E_c = ETX(l, d) + ERX(l) \quad (3.1)$$

where

$$ETX(l, d) = E_{elec} * l + E_{mp} * l * d \quad (3.2)$$

and :

$$ERX(l) = E_{elec} * l \quad (3.3)$$

where :

- $ETX(l, d)$: Energy consumed when transmitting a message.
- $ERX(l)$: Energy consumed when receiving a message.
- l : The message's size in bits
- E_{elec} : Enough energy to send or receive a single bit.

- Emp: Represents the amplification energy.
- d: The length of the distance between the sender and the receiver.

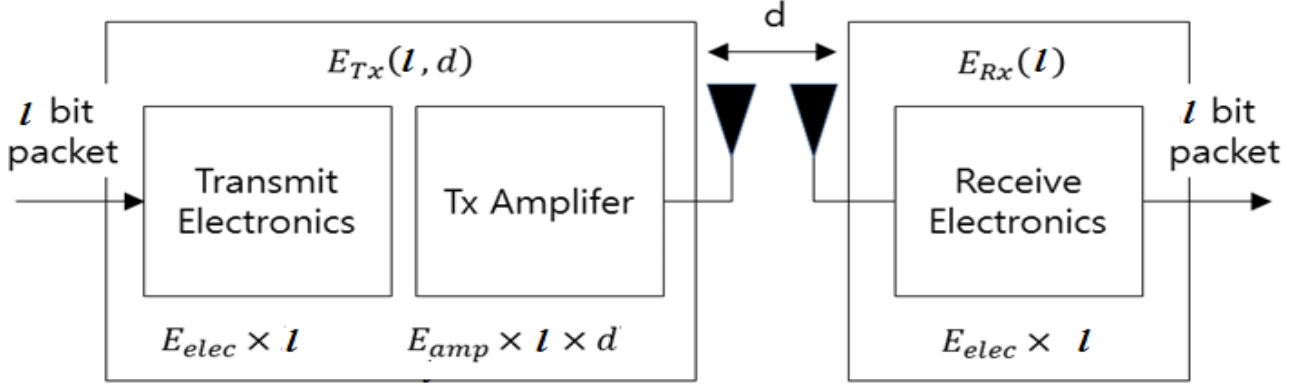

Figure 3.3: Energy model [14].

3.3 Detailed description

This protocol operates through a structured sequence of three key phases: The configuration phase, the data routing phase, and the maintenance phase for clusters.

3.3.1 Configuration phase

A) Levels construction:

The BS divides the network into L layers to allow communication between the CHs in neighboring levels by employing the minimum radio transmission range Tr_{min} . The number of layers (L) is determined by two key parameters , the minimum radio transmission range of the nodes, Tr_{min} , and the maximum distance between the sink and the farthest node D , as follow [29] :

$$L = \frac{D}{Tr_{min}} \quad (3.4)$$

Where Tr_{min} indicates the distance that a node can send the data in the form of electromagnetic waves.

After this phase, the network is divided into L layers, and each node is given an id_{layer} to indicate what level it belongs , by the following formula [29] :

$$id_{layer} = \frac{d}{Tr_{min}} \quad (3.5)$$

where d is the distance between a sensor node and the BS .

B) k-means clustering algorithm

Our approach permits the network to be divided where the closest nodes are grouped together. This phase is in charge of the network's distribution according to geographic location. The K-means machine learning algorithm is an easy and efficient method for clustering large databases (thousands of sensors), the algorithm works as following steps [29]:

i) Initialization : Initially, 'k' cluster centroids are randomly selected from the sensor nodes in the selected layer . These centroids represent the initial cluster heads.

ii) Assignment : Every sensor node measures the separation between each cluster centroid and peers with the centroid that is closest to it. It is ensured by this assignment method that every sensor is a part of a single cluster.

iii) Updates : When every sensor node has been allocated to a cluster, the mean of every sensor node inside each cluster is calculated to update the cluster centroids. The cluster heads that have been updated are represented by these centroids.

iv) Iteration : In order to achieve convergence , step two and three are repeated Iteratively. Convergence occurs after a defined number of iterations or when the cluster centroids stay comparatively stable.

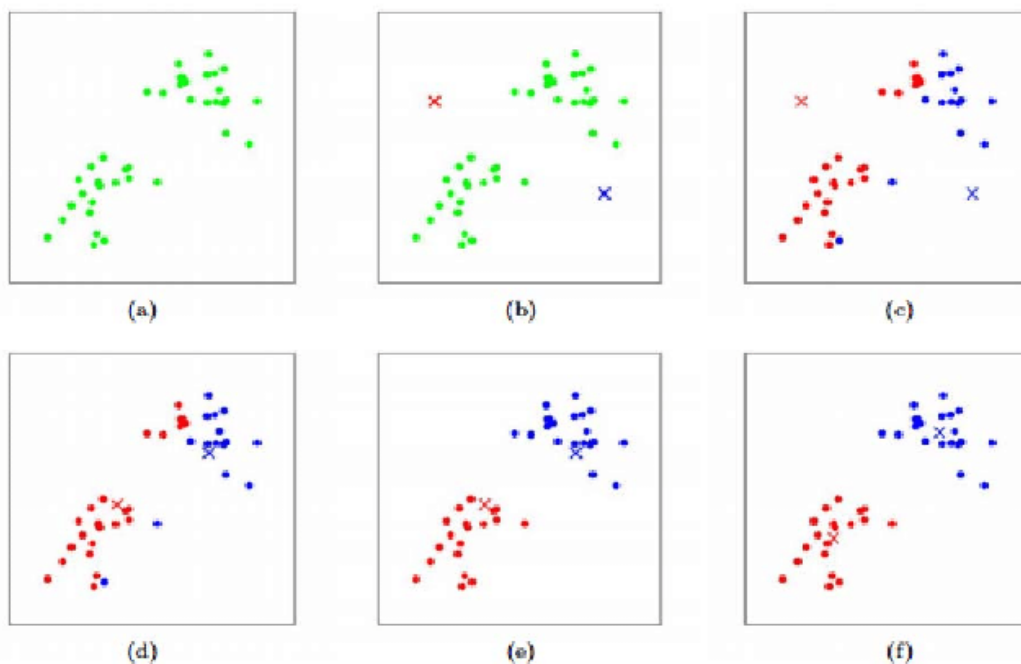

Figure 3.4: k-means clustering steps[15].

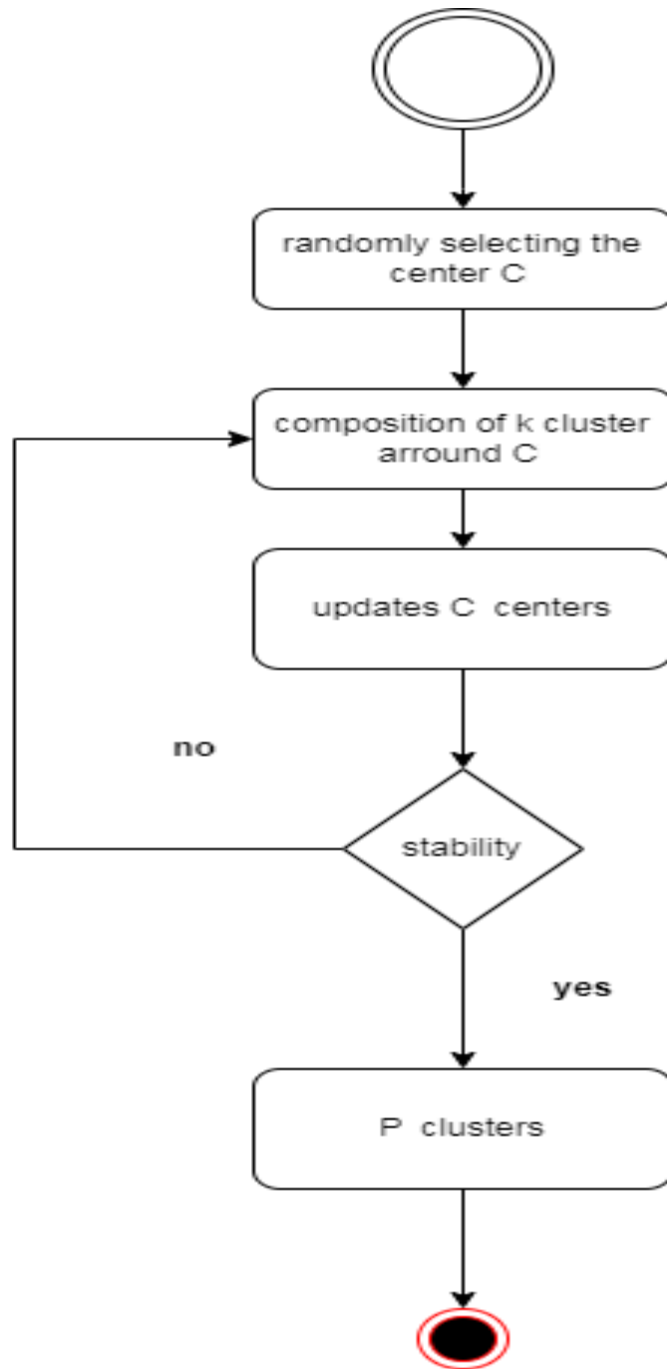

Figure 3.5: k-means process for network clustering

K-Means offers several advantages in WSN clustering :

a) Fault tolerance:

K-Means can simply reassign sensors to new cluster heads in the event of a cluster head failure, negating the need for a full network reconfiguration [29].

b) Energy efficiency:

K-Means clustering uses less energy during data transmission by minimizing the distance between sensors and the cluster heads that correspond to them[29].

c) Scalability:

K-Means divides sensors into clusters efficiently without requiring global network information, making it appropriate for large-scale WSNs[29].

d) Load balancing:

K-Means assists in balancing the energy load throughout the network, preventing premature battery depletion in certain sensors, by distributing sensors equally among clusters [29].

e) Effective:

K-means works best in hyper-spherical or circular clusters[15].

B) Clusters construction :

In this phase we try to find the ideal number for clusters in each level, the CH node needs to be within radio range of each cluster member. For-that , the ideal K is obtained as indicated in the reference [29] :

$$k(l) = \frac{n(l)}{l * L} \quad (3.6)$$

Where $n(l)$ denotes the count of nodes in layer l .

There are two main obstacles : the first is the unknown number of ideal clusters, the second is the radio range of the sensor nodes inside a cluster. In order to collect sensing data from cluster members, each cluster needs to designate a CH. The CH node needs to be within radio range of every cluster member.

After each level clustering , its validity will be evaluated . If all members are in the radio range of CHs in a level l equal to the total number of node $n(l)$, then K will be accepted. Else k will be incremented and reassessed again :

D: The distance of the farthest node from BS ;
 Trmin : The minimum radio transmission range of a sensor node;
 [CHs] : List of cluster heads ;
 L : The number of layers;
 n(l) : The number of nodes in each layer l;
 N(L1): List of nodes of the first level ;
 K(l): The number of clusters in each layer l ;
Start
 $L \leftarrow \frac{D}{Trmin};$
 [CHs] $\leftarrow N(L1);$ /* Nodes of the first level will be counted as CHs */
 $k(l) \leftarrow \frac{n(l)}{l * L};$
 $M \leftarrow 0;$
for $l=2$ to L **do**
 while TRUE **do**
 CLUSTER LEVEL l WITH k-MEANS METHOD ;
 for ALL CLUSTERS **do**
 $M \leftarrow M +$ SENSORS NODES COVERED BY CH RADIO RANGE ; /* Calculate the total of sensor nodes covered by the radio range of all CHs in a level l */
 end
 $M \leftarrow M + K(l);$
 if $M = n(l)$ **then**
 | **return** false
 else
 | $K(l) \leftarrow K(l) + 1$
 end
 end
end
End

Algorithm 1: Clusters construction algorithm

3.3.2 Data transmission phase

During this stage, the network gathers and sends data to the BS via multi-hop communication. As a result, the sensor nodes consume less power and the network's operational lifetime is extended.

A) Intra-cluster data transmission:

In order to avoid collisions and save energy, we employed the TDMA scheduling which assigns time slots to sensor nodes. This allows sensor nodes to shut-down their communication interfaces When not use it and conserve power. The CHs then combine information from various nodes and aggregate it to reduce redundancy . The transmission of this aggregated data is subsequently routed to relay nodes, improving network efficiency and optimizing transmission.

B) Inter-cluster data transmission:

Every CH sends its gathered data to the CH at the next lower network tier or the same tier if it is closer to the Base Station (BS). Unlike the sensor nodes of the first level which are considered as CHs. They send their data directly to the BS. This adoption of multi-hop routing down to the BS is an energy-efficient tactic that increase the network's longevity.

3.3.3 Clusters maintenance phase

This phase is a crucial part of the network cycle. It ensures the longevity and efficient functioning as it contains the managements of clusters and their cluster heads (CHs) which plays a principal role in data transmission and network operations . Below is a summary of the main procedures and systems includes :

A) Updating cluster heads

When a node's energy completely runs out during a transmission, this node becomes inoperable and is unable to send data. As a result, the CH nodes are upgraded to handle this issue. The CH nodes are regularly switched out in a rotating fashion to avoid depleting the CH node's energy. As a consequence , the energy consumption of each node would be balanced which allows us to extend the lifetime of the network. Here, when choosing a new CH to rotate the CH role among the nodes these condition will be considered :

- 1- It must be in the radio range of all cluster members
- 2- The distance to the BS is taken into account .
- 3- The remaining energy is more than the cluster's average node energy.
- 4-They've retained at least 30 percent of their initial energy, or maybe another threshold can be chosen

B) CH energy depletion detection:

During this stage, the cluster heads' (CHs') energy levels are tracked by the system. The system recognizes this depletion when a CH's energy level gets close to a predetermined threshold (e.g., 30 percent of its starting energy) , or a lower threshold.

C) Direct data transmission:

In this phase , The CHs of the second level will be transmitting their data directly to the BS if the remaining nodes in the first level is equal or less then one third $\frac{1}{3}$ of the initial total sensor nodes in the first level $n(L1)$.

3.3.4 Sequence diagram

Our method's overall procedure is explained as follows:

- First we start dividing the network area in layers based on geographical location in comparison to the BS
- Second , using the K-means approach, we begin partitioning the network . Where the closest nodes are grouped together .
- This k-means clustering will be assessed , until finding the ideal k for each level .
- Once the CH is determined, the sensors transmit their data to CH, who aggregates it and sends it to next CH of a lower level down to BS .

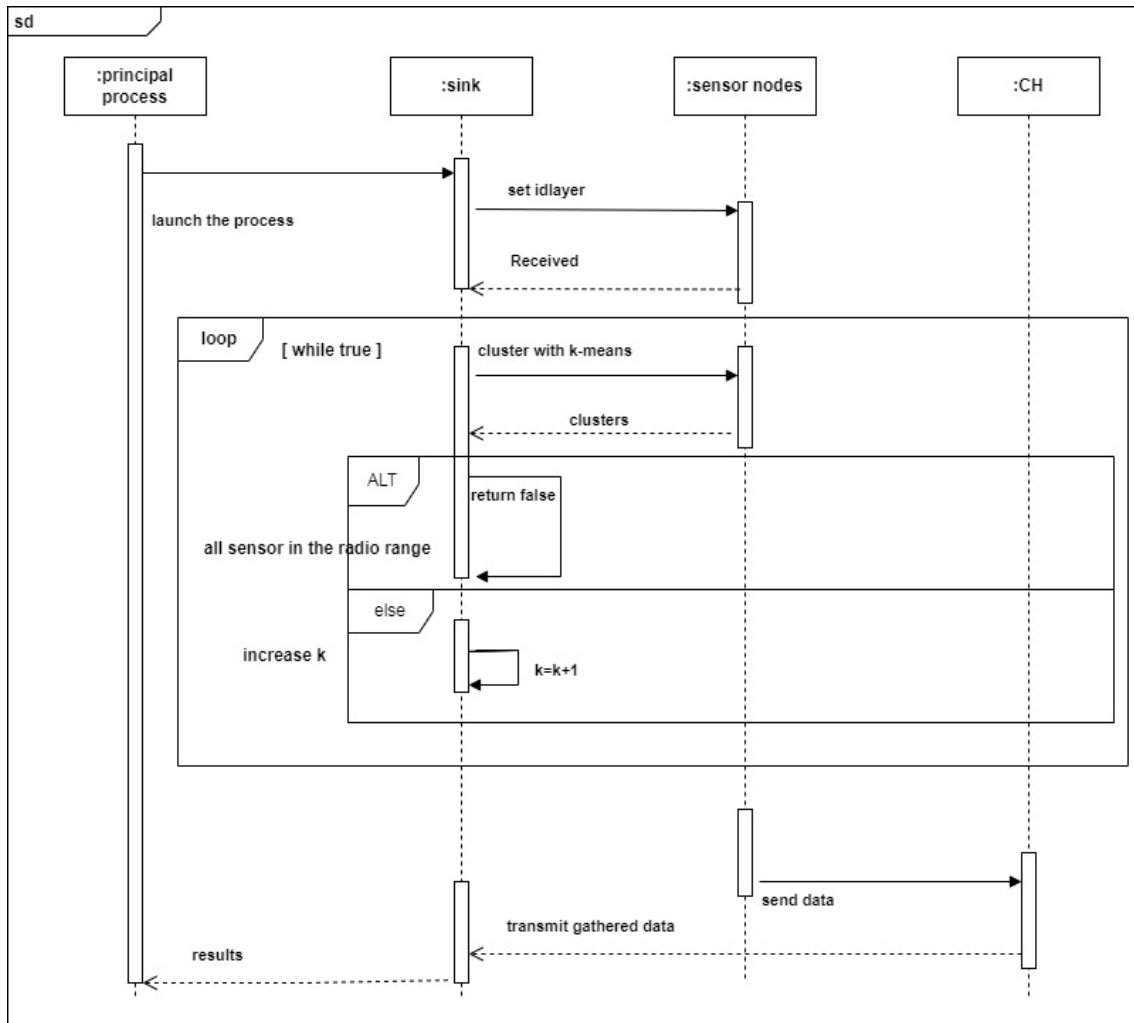

Figure 3.6: Sequence diagram

3.4 Conclusion

In this chapter we explained in detailed our proposal which based on k-means clustering concepts to come-up with a new protocol that aims to prolong network lifespan. With a multi-layer circular network where the BS is in the centroid .

We talked in detailed about the concepts and gave a brief sequence diagram. In the next chapter we will evaluate this protocol.

Chapter **4**

Simulations and results

4.1 Introduction

we present the results obtained from simulations using our implemented protocol approach aimed at tackling energy issues in WSNs. Additionally, we summarize the platforms and development tools employed for implementing various system components. The chapter concludes with an overview of the overall results achieved, followed by a concise discussion.

4.2 Simulation resources

For the implementation of our new protocol approach, we utilized the next resources :

4.2.1 Software resources

MATLAB is a system featuring a programming language that enables direct expression of matrix and array operations, integrating a desktop environment intended for iterative analysis and design methods. This all-inclusive platform includes the Live Editor, which makes it easier to create executable notebooks by combining code, output, and formatted text in one seamless package [16]. We used MATLAB R 2023 B



Figure 4.1: MATLAB icon. [16]

4.2.2 Hardware tools

We employed a Lenovo laptop equipped with an Intel(R) Core(TM) i3-2328M CPU running at 2.20GHz, complemented by 8.00 GB of RAM (7.88 GB usable). The system operates on a 64-bit architecture and runs Ubuntu 22.04.4 LTS as its Linux-based operating system. This setup provided a reliable platform for implementing and testing our protocols and simulations, ensuring efficient computation and reliable performance throughout our research endeavors.

4.3 Network model

Sensor nodes are dispersed randomly throughout the 600 m x 600 m area. The central position of the base station is (300, 300). All of the simulated network's

nodes begin with an initial power of $E_0 = 1$ Joule and have an infinite supply of data that they can send to the base station.

4.4 Simulation

The simulation's parameters are listed in the following tables:

4.4.1 Network parameters

The network parameters are displayed in the table below:

Parameters of the Network	
Parameters	Value
Dimensions of the area	600m x 600m
Nodes being deployed	Randomly
Packet size	1000bits
Radio transmission range	100m

Table 4.1: Network parameters.

4.4.2 parameters of the node

The nodes' parameters are displayed in the table below:

parameters of the node	
Parameters	Value
The quantity of nodes	100
number of rounds	800
Location of the BS	(300,300)
Node IDs	[1-100]

Table 4.2: Node parameters.

4.4.3 Energy-related parameters

The energy parameters are displayed in the table below:

Energy-related parameters	
Parameters	Value
Each node's starting energy	1 joule
The nodes' total starting energy	100 joules
Energy consumed when transmitting a packet	3 pico joules
Energy consumed when receiving a packet	3 pico joules
Energy consumed with data aggregation	0.1 pico joule
Energy consumed when amplify a packet	3 pico joules

Table 4.3: Energy parameters.

4.4.4 Nodes deploying

The node deployment is depicted in the following figure:

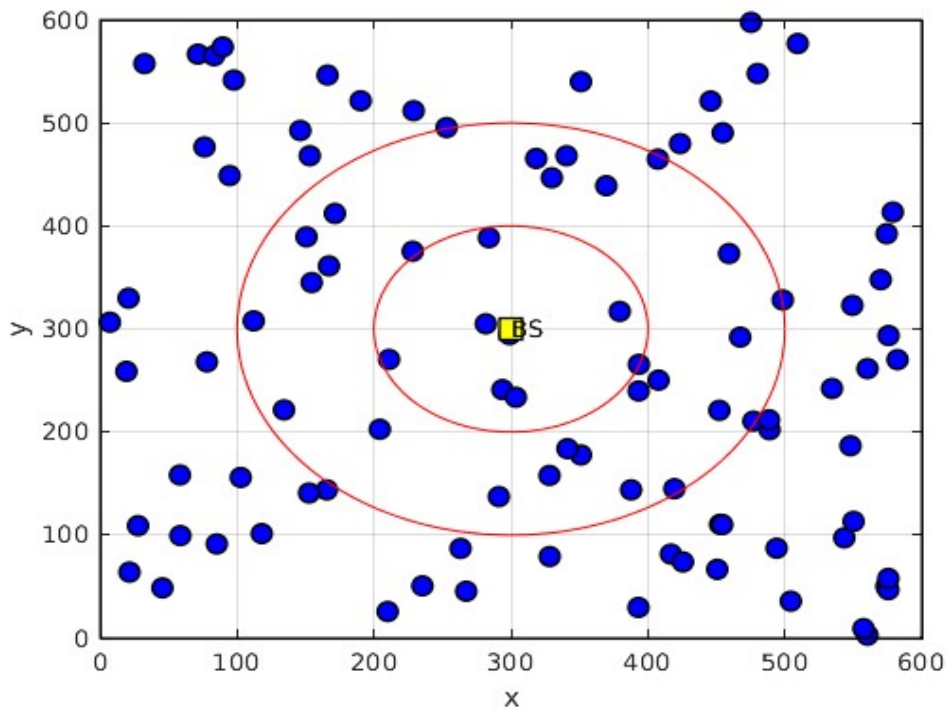

Figure 4.2: Nodes deploying.

4.4.5 Packets transmission

After running the protocol the packets sending starts as shown below:

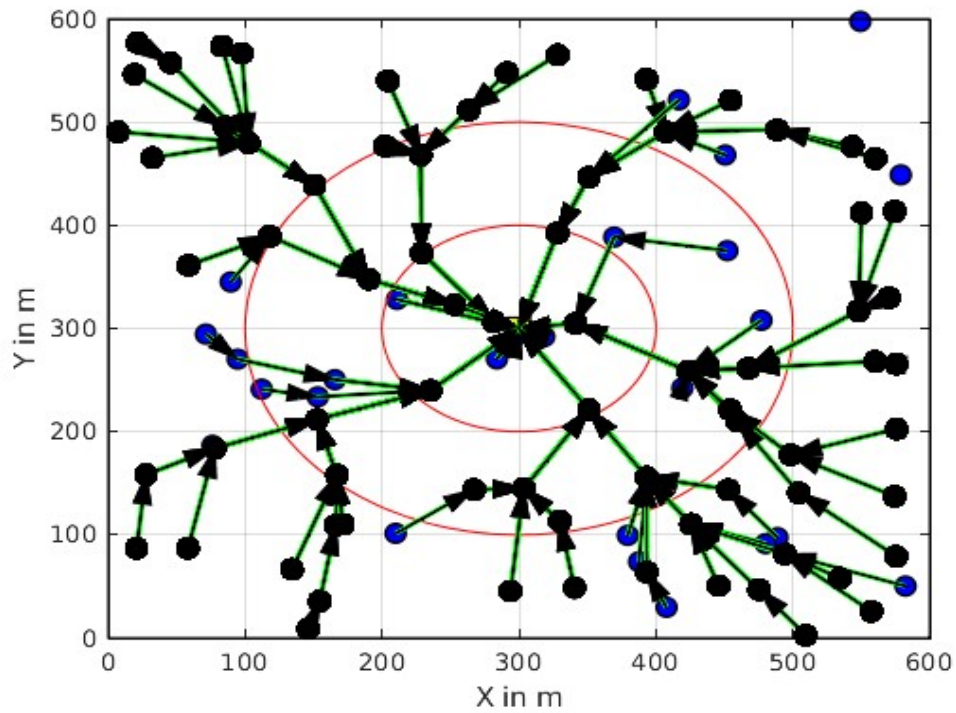

Figure 4.3: Packets transmission.

4.5 Results and discussions

4.5.1 Alive nodes

Figure 4.4 displays the number of alive nodes after 800 rounds in both LEACH protocol and our proposal. We note that our proposal shows better network resilience by maintaining more sensor nodes alive. This suggests that our proposal energy-efficient clustering strategy which combine single-hop with multi-hop routing contribute to prolonged network operation.

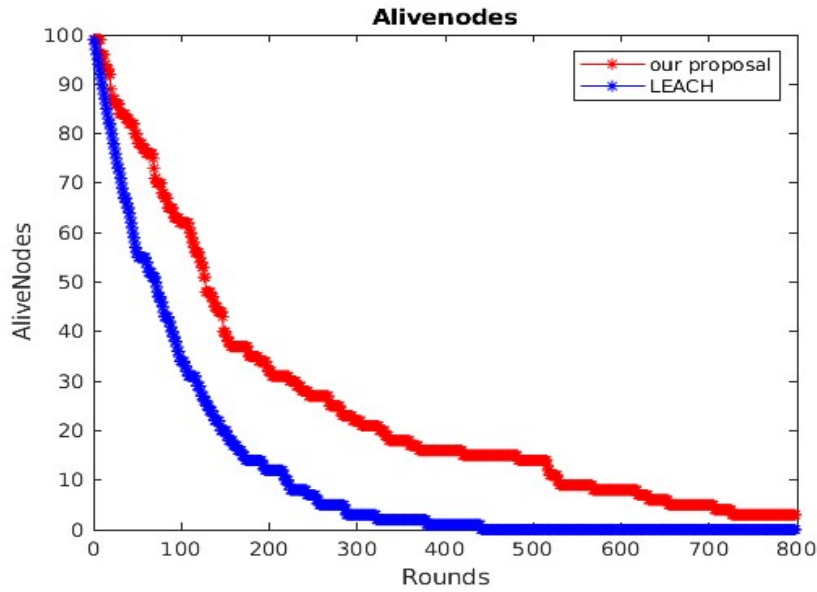

Figure 4.4: Alive nodes.

4.5.2 Energy levels

Figure 4.5 and Figure 4.6 illustrate the energy consumption for both our proposal and LEACH protocol. It's evident that there is a notable differences between the two protocols: Our proposal outperforms LEACH and demonstrates superior performance in terms of energy efficiency. We note that with LEACH all nodes have consumed their energy after 400 Rounds. Compared to our proposal, a certain number of nodes conserve energy even after 500 rounds.

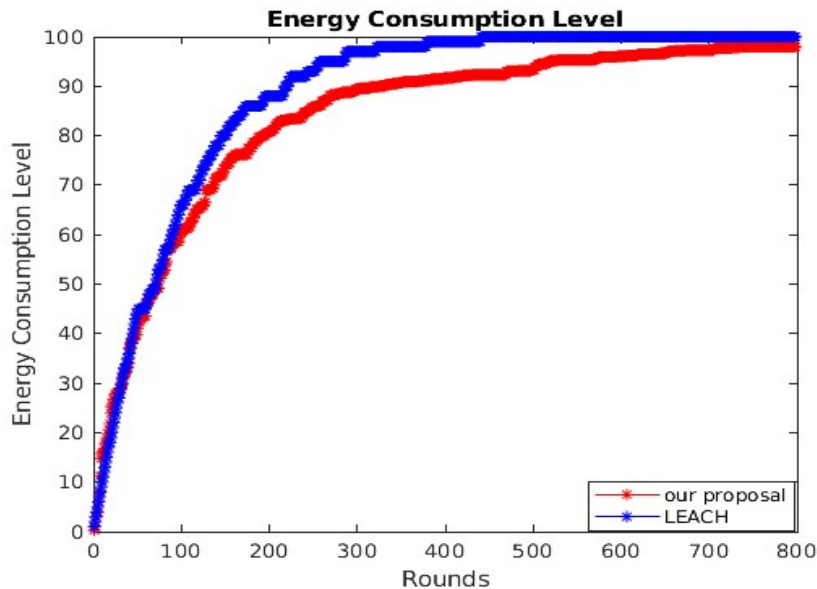

Figure 4.5: Energy consumption level.

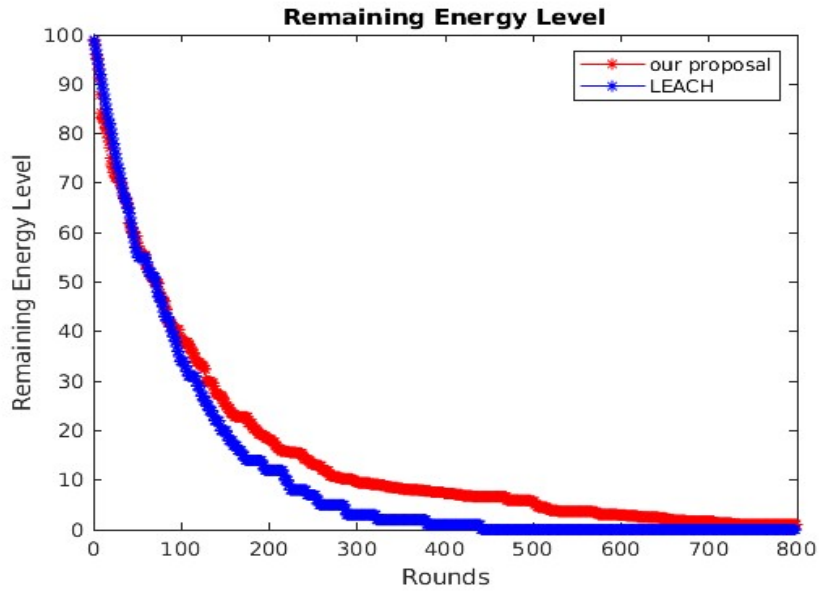

Figure 4.6: Remaining energy level.

4.5.3 Data delivery to BS

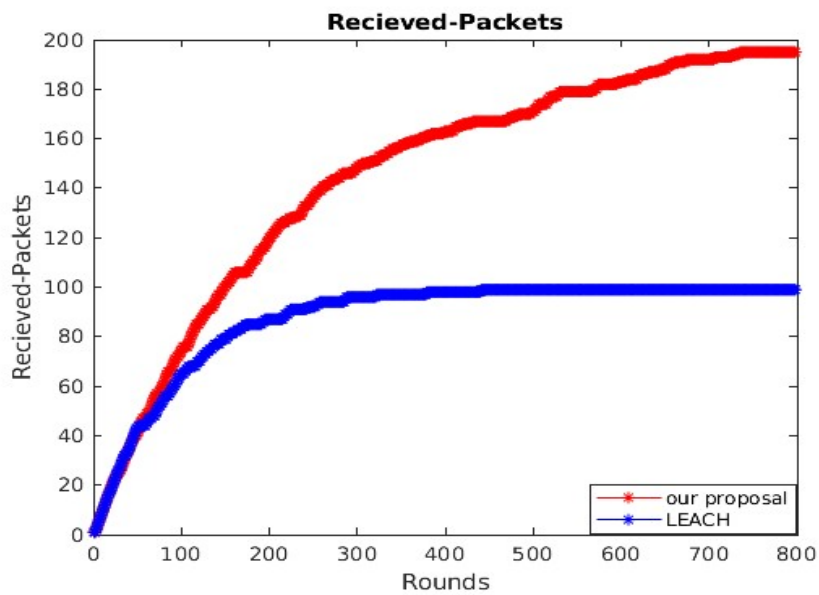

Figure 4.7: Packets delivery.

In Figure 4.7 we notice that our proposal has an increased number of packets delivered to the BS compared to LEACH due to nodes longevity lifetime.

4.6 Conclusion

This chapter delved into the resource used for the simulation and the parameters, along with a comparison of our protocol with LEACH. Our novel protocol successfully maximizes network lifetime, surpassing LEACH in energy efficiency and packets delivery to the BS, demonstrating its effectiveness in enhancing network operations.

General conclusion

In our work we are interested in the problem of conservation of energy in a network of wireless sensors. The sensor nodes are powered by low capacity batteries, Generally irreplaceable because the nodes sensors are deployed in difficult to access areas. In order to extend the duration life of the sensor network by minimizing energy consumption, several solutions are proposed . The majority of these solutions try to avoid the various causes of loss of energy. Generally, these solutions are not optimal enough, which leaves energy in a sensor network an open research problem.

Our proposed methodology is a combination of leach and k-means methodologies, with a new logic that includes circular levels and a centric BS surrounded by nodes. We have integrated a single-hop and multi-hop routing and implemented an algorithm that can choose the ideal k to create clusters for each level . Our proposed technique was compared against LEACH to assess its effectiveness. All methods used in this investigation were simulated. Using Ubuntu 23.04 LTS and Matlab 2023 .

The results shows that our protocol has accomplished the achievement of power dissipation management comparing with LEACH and a significant improvement in terms of power consumption , lifetime and data, which indicates that our new protocol has achieved the intended goals.

Bibliography

- [1] Md. Azharuddin, Pratyay Kuila, and Prasanta K. Jana. Energy efficient fault tolerant clustering and routing algorithms for wireless sensor networks. *Comput. Electr. Eng.*, 41:177–190, 2015.
- [2] Jennifer Yick, Biswanath Mukherjee, and Dipak Ghosal. Wireless sensor network survey. *Computer Networks*, 52:2292–2330, 08 2008.
- [3] Karthik Soundarapandian and Ashok Kumar. Challenges of wireless sensor networks and issues associated with time synchronization. 03 2015.
- [4] Ian F. Akyildiz and Erich P. Stuntebeck. Wireless underground sensor networks: Research challenges. *Ad Hoc Networks*, 4(6):669–686, 2006.
- [5] Lei You and Chungui Liu. Robust cross-layer design of wireless multimedia sensor networks with correlation and uncertainty. *JNW*, 6:1009–1016, 07 2011.
- [6] Abdelrahman Abuarqoub, Mohammad Hammoudeh, Bamidele Adebisi, Sohail Jabbar, Ahcène Bounceur, and Hashem Al-Bashar. Dynamic clustering and management of mobile wireless sensor networks. *Computer Networks*, 117:62–75, 2017. Cyber-physical systems and context-aware sensing and computing.
- [7] Himanshu Sharma. Modulations and error correction codes for wireless sensor networks. 11 2019.

- [8] Khalid Haseeb, Ikram Ud Din, Ahmad Almogren, and Naveed Islam. An energy efficient and secure iot-based wsn framework: An application to smart agriculture. *Sensors*, 20, 04 2020.
- [9] Kumar Batta, Gurrala Venkateswara Rao, and Y.V. Srinivasa Murthy. A node to node security for sensor nodes implanted in cross cover multi-layer architecture using mc-nie algorithm. *Evolutionary Intelligence*, 14:1–17, 06 2021.
- [10] Dr.Monica Mundada, Savan Kiran, Shivanand Khobanna, Raja Varsha, and Seira George. A study on energy efficient routing protocols in wireless sensor networks. *International Journal of Distributed and Parallel Systems*, 3, 06 2012.
- [11] H.Y. Shwe, Arun Kumar, and P.H.J. Chong. Building efficient multi-level wireless sensor networks with cluster-based routing protocol. 10:4272–4286, 09 2016.
- [12] Ouadoudi Zytoune and Driss Aboutajdine. An optimized energy aware chaining technique for data gathering in wireless sensor networks. *International Journal of Digital Information and Wireless Communications (IJDIWC)*, 3:41–49, 01 2013.
- [13] Anitha Gandhi, Vijaya Kumari, and S. Thangavelu. A comprehensive study and analysis of leach and heed routing protocols for wireless sensor networks – with suggestion for improvements. *Indonesian Journal of Electrical Engineering and Computer Science*, 9:778–783, 03 2018.
- [14] Krit Salah-ddine, Hassan Ouadani, and L. Elmaimouni. Combining leach, pegasis hierarchical protocol and constraint distance to increase the lifetime of wireless sensor networks. 8, 07 2018.
- [15] Sen Yang, Dave Towey, and Zhi Quan Zhou. Metamorphic exploration of an unsupervised clustering program. pages 48–54, 05 2019.
- [16] Matlab. https://www.mathworks.com/products/matlab.html?s_tid=hp_ff_p_matlab. 2024.
- [17] Robert Sheldon. <https://www.techtarget.com/whatis/definition/sensor>, 2022.
- [18] Ved Prakash, Suman Pandey, and Ashish Kumar Singh. Basic introduction of wireless sensor network. In *Proceedings of 2nd*

- International Conference on Advanced Computing and Software Engineering (ICACSE)*, 2019.
- [19] Omkar Javeri and Amutha Jeyakumar. *Wireless Sensor Network Using Bluetooth*, pages 424–432. 01 2011.
- [20] Sanjay Waware, Nisha Sarwade, and Pallavi Gangurde. A review of power efficient hierarchical routing protocols in wireless sensor networks. *International Journal of Engineering Research and Applications (IJERA)*, 2(2):1096–1102, 2012.
- [21] Xiaoqiang Liu, Mingxue Li, Yufeng Zhang, Xiwen Zhu, and Yuesheng Guan. Self-powered wireless sensor node based on rf energy harvesting and management combined design. *Energy Conversion and Management*, 292:117393, 09 2023.
- [22] Jun Zheng and Abbas Jamalipour. *Wireless Sensor Networks: A Networking Perspective*. 09 2009.
- [23] Samira Kalantari and Sara Taghipour. A survey on architectures, protocols, applications, and management in wireless sensor networks. *Journal of Advanced Computer Science Technology*, 3, 01 2014.
- [24] Michail Papoutsidakis, Eleni Symeonaki, Dimitrios Piromalis, and Christos Drosos. The use of wireless sensors network for supporting human daily activities. 11 2018.
- [25] Usman Nazir. *Analysis of Energy Efficient Hierarchical Routing Protocols in Wireless Sensor Networks*. PhD thesis, COMSATS INSTITUTE OF INFORMATION TECHNOLOGY, ISLAMABAD, 2012.
- [26] Dongliang Xie, Wenping Wei, Yu Wang, and Hongsong Zhu. Tradeoff between throughput and energy consumption in multirate wireless sensor networks. *Sensors Journal, IEEE*, 13:3667–3676, 10 2013.
- [27] Khawar Malik and Muhammad Mateen Yaqoob. An analytical survey on routing protocols for wireless sensor network (wsn). *International Journal of Computer Applications*, 107:40–45, 12 2014.
- [28] Xuxun Liu. Clustering routing algorithms in wireless sensor networks: An overview. *KSII Transactions on Internet and Information Systems*, 6, 07 2012.

- [29] Akli Abbas, Oukas Nourredine, Samia Haboussi, and Amad Mourad. A novel energy-efficient hierarchical routing protocol (eehrp) for iot networks using k-means machine learning. pages 1–6, 11 2023.